

TORQUEEDO



Electric mobility on the water
Commercial Applications

Is electric right for your business?



Autonomous vessels



Excursions



Workboats

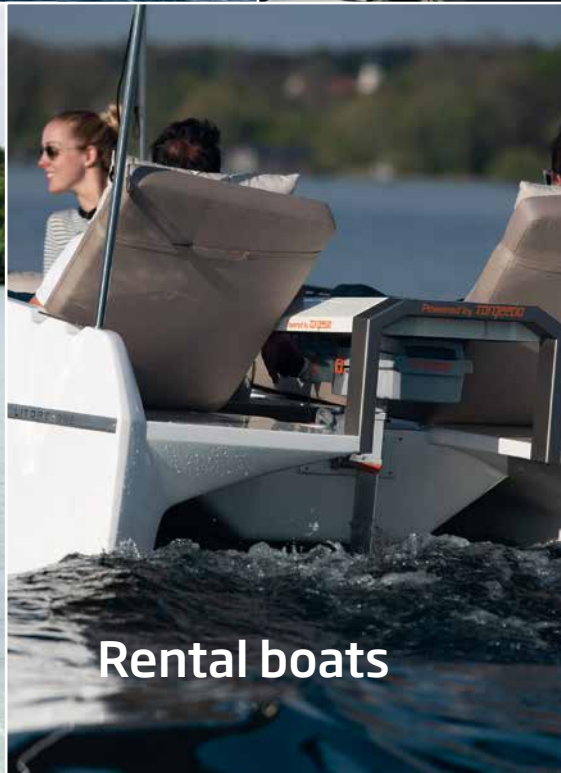

Rental boats



Coach boats



Ferries and taxis

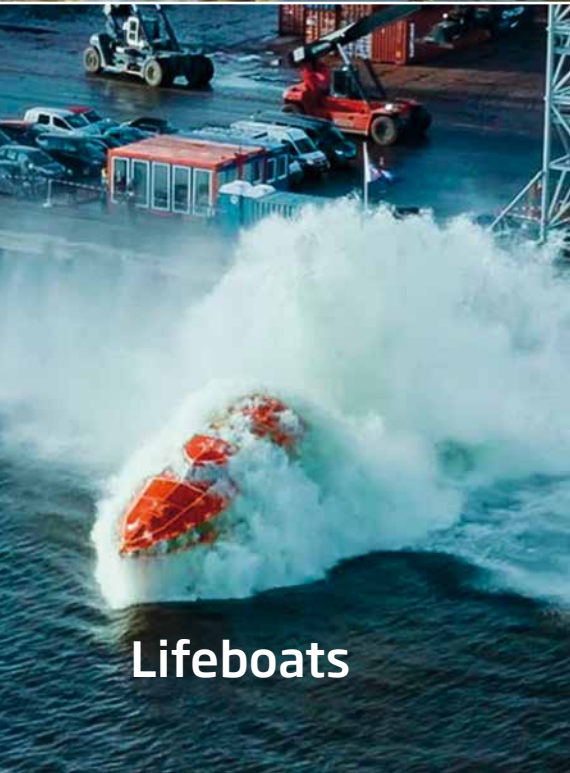

Lifeboats

Let's talk about it.

Torqeedo has been answering the question "Is electric right for me?" every day since 2005. The answers are as varied as our commercial applications, which range from water taxis, ferries and tour boats to quarry barges and life rafts. You should explore electric if you want:

Lower carbon footprint - lower your carbon footprint with a renewable source, 95 to 100% emission-free. Or by 30 to 70%, even if your power is provided by coal.

Zero local emissions - a diesel-powered ferry emits air pollution roughly equivalent to that produced by 40 diesel buses. Repowering with a fully electric driveline eliminates urban air quality and human health impacts completely.

Increased uptime - a vastly reduced maintenance schedule means more time on the water and more money in your pocket.

Service anytime, anywhere - we don't deliver components, we deliver complete systems. With our global network of service centres and service partners, we'll get you up and running quickly, no matter where you are.

Lower fuel costs - electricity costs are much lower and more stable than petrol or diesel. It costs €8 to charge a high-capacity Deep Blue battery from 0 - 100%, using the average European electricity price. In the US, it costs less than \$5.

Less noise - concerns about noise pollution can prevent or limit operation in environmentally sensitive and urban areas. Electric offers a quiet, fume-free ride and much less vibration on board. It's a powerful way to increase customer enjoyment and the well-being of your crew, while benefiting nature and your neighbors.

More manoeuvrability - Torqeedo's motors offer a significant torque advantage at low rpm, resulting in unparalleled manoeuvrability and acceleration. Direct-drive electric motors can switch from forward to reverse indefinitely without damage while station-keeping or operating in confined areas.

Environmental excellence - going electric sets your company apart and provides a competitive advantage for gaining funding, permits and customers in the marketplace.

A conversation with a member of our highly trained sales staff is the best way to explore how electric fits your business.

Give us a call today.

A decision that pays off

In commercial applications, electric mobility is often not only ecologically superior, but also economically. Due to the substantially lower operating costs, electric propulsion systems often feature lower total cost of ownership and help commercial operations improve financial performance.

Will electric save me money?

Are your fuel costs higher than €4,700 per year? If they are, it might be worth switching to Deep Blue today. For power classes up to 10 kW, Cruise drives may reduce costs if your annual fuel costs exceed €1,000.

Up to a 9-year capacity warranty

Accurately evaluating the costs of going electric depends on the service life of the battery system. Deep Blue comes with a long-term battery capacity warranty: up to 9 years after commissioning, the batteries will retain 80% of their original capacity, even if you use them every day*. The battery capacity status can be viewed at any time via the onboard computer.

Lower maintenance costs

An electric drive system requires less maintenance than comparable systems burning fossil fuels.

* Battery warranty varies from 4.5 to 9 years depending on usage and average temperature. Please see Deep Blue Outline Document for details.

- Save 100 % of your gasoline or diesel costs
- + Spend a fraction of saved costs on electricity and battery write-off
- + Reduce maintenance costs
- + Enjoy high reliability
-
- = **If you are out on the water 100 days a year or more, you may save money by going electric, while lowering your carbon footprint**

We will be pleased to provide you with a calculation tailored to your requirements.

info@torquedo.com

Contents

- 6 Why Torqeedo**
- 6 New mobility:**
Explore the global trends shaping marine mobility
- 7 The green fleet:**
What does the fleet of the future look like?
- 8 Superior performance:**
The benefits of going electric
- 9 Convenience and predictability:**
Easy to use and easier on your budget
- 10 Advanced engineering:**
Why choose Torqeedo?
- 12 Your global support crew:**
Wherever, whenever. Our e-mobility experts are ready to help.
-
- 12 Contact service centres**
- 60 Contact**



14 Deep Blue and Deep Blue Hybrid

Powerful electric motors and automotive-grade lithium batteries, fully integrated and industrially engineered for the most demanding applications

- 16 Deep Blue drives**
- 17 Deep Blue systems**
- 18 Deep Blue drives technical data**
- 20 Deep Blue battery technology**
- 22 Deep Blue batteries and genset**

24 Deep Blue success stories

- 24 Tornado coach boat
- 25 Waste Cleaner 66
- 26 Swedish rescue boat
- 27 Sea Robotics
- 28 Freefall lifeboat from Verhoef
- 29 Ottawa ferry
- 30 German quarry boat
- 31 Solar ferry in Spain
- 32 Eco-tourism in Vietnam
- 33 Workboat in France



34 Cruise and Travel

Low-voltage workhorses for vessels up to 10 tons, ideally suited for everyday use

- 36 Cruise drives**
- 38 Cruise systems**
- 39 Travel drives**
- 40 Cruise and Travel technical data**
- 42 Power battery technology**
- 44 Power batteries**

46 Cruise and Travel success stories

- 46 Water Witch clean up boat
- 47 Hunters Yard
- 48 Kenya
- 49 XOCEAN
- 50 Commuter ferry in Thailand
- 51 Hydrography boat
- 52 Chinese workboat
- 53 Solar-powered pump-out boat
- 54 Google's autonomous vessel
- 55 Eco Dive boats in Raja Ampat

The new mobility revolution

Global trends are driving technological advancements and producing new opportunities. Will you be on board?

Transportation, fossil fuels and climate

The Paris Agreement is the first comprehensive global climate protection agreement and it will fundamentally alter how we move people and products over the next few years. One of the key Paris goals is to peak global greenhouse gas (GHG) emissions as soon as possible, paving the way toward climate neutrality.

Transportation currently contributes almost one-quarter of energy-related GHG emissions and is growing faster than any other end-use sector. Transitioning the light commercial fleet, such as port security, support vessels, freight transporters in urban areas and other workboats, to emission-free electric drives will be the first steps toward reducing the overall carbon footprint of the maritime industry,

Paris Agreement participant countries are expected to eliminate fossil fuel industry subsidies within the next few years, moves which would bring an end to artificially low fuel prices and accelerate the adoption of electric mobility across industries.

Urbanization and human health

By 2050, the global population is projected to reach 10 billion, with 75% of people residing in cities. Facing this rapid population shift and the resulting gridlock of land-based transportation, urban planners are looking to their waterways to ease congestion on city streets, creating integrated water-land public transport networks with climate-friendly water taxis, ferries and other passenger vessels.

Urban air quality problems are also driving the switch to clean e-mobility. Amsterdam's transport chief recently said residents live a year less on average due to dirty air as the city banned combustion-powered vehicles from its historic center. The city's canals will be emission-free by 2025 and streets will follow by 2030. Projects to develop charging and related infrastructure are already underway.

Other cities moving to electrify their waterways include Paris, Istanbul, which is deploying a fleet of 100 electric boats for commuters, and Bangkok, which is reviving its ancient canals and creating an integrated network of urban rail and electrified waterway transit systems.

A maturing e-mobility ecosystem

Battery tech: New electric vehicles (EVs) have longer range and larger and faster vehicles can be powered by electric or hybrid drives due to steady technical improvements in energy storage. Torqeedo is leveraging these advances by integrating BMW battery technology into electric drive systems for the marine market.

Green charging: Building renewable electricity production is already less expensive than adding fossil fuel-powered sources, and renewables accounted for 72% of all newly installed net power capacity in 2019. As renewable capacity grows, it reduces the need to charge EVs with electricity generated from polluting sources.

As the ecosystem matures, electric mobility grows more practical, beneficial and sustainable.

The future-proof fleet



Peace and quiet

Noise pollution concerns can prevent operation in urban or sensitive areas. Electric drives are quiet and improve crew health and passenger enjoyment with no exhaust, vibration and fumes.



Healthier air and climate

Electric motors don't contribute to air pollution and typically have a lower carbon footprint of 60 to 95%, depending on the energy mix available for charging.



Fast, convenient charging

Charging is quick, easy, clean and fume-free; many docking locations are already equipped with shore power connections.



Zero pollution

Even a drop of spilled fuel can contaminate thousands of litres of water and cost your business time and money. Electric drives reduce the risk of fuel and oil spills and have lower maintenance requirements.

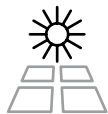

Reduced fuel costs

Electricity prices are much lower and more stable than fossil fuels. Efficient solar panels can help keep batteries charged, as the sun never sends a bill.



Plenty of power

With increased battery capacity, propulsion and all onboard equipment can be powered by electricity, with fully integrated generator backup if needed.

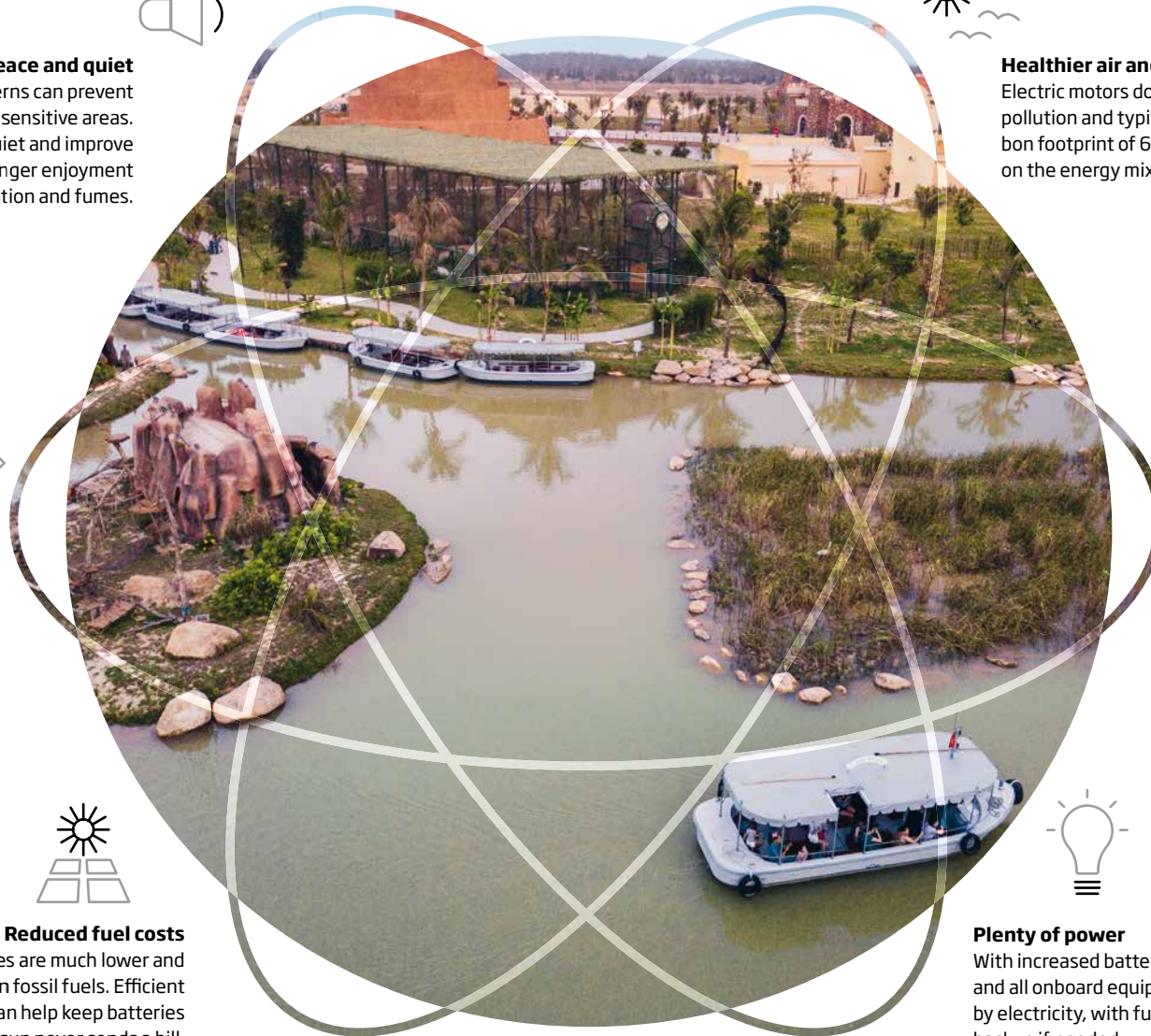

Superior efficiency and performance

Our focus: optimising propulsive power and overall efficiency

Measuring power and performance

The most meaningful performance indicator of a drive system is propulsive power, which indicates the power delivered by the motor to drive the boat, taking all losses, including propeller losses, into account. This method has been used in commercial shipbuilding for nearly 100 years.

Manufacturers of combustion engines often advertise less informative measurements, such as the shaft power, input power or even the static thrust. That wouldn't be so bad if the differences between power ratings were minimal, but that isn't the case: a gasoline outboard with an advertised shaft power of 5 HP actually provides a mere 1.4 HP of propulsive power.

The efficiency advantage

Torqueedo efficiency ratings not only refer to motor efficiency, but also disclose losses in motor, electronics, cables, gears and propellers. Thanks to our focus on optimising the entire system, Torqueedo motors deliver the highest overall efficiency on the market. When combustion engines burn petrol or diesel, they primarily use the stored energy to produce heat; 5-15% of the supplied energy is used to propel the boat and the rest is lost due to inefficiencies. A Torqueedo drive converts between 44 and 56% of the available energy into propulsive power, extending range and runtime. A Cruise 10.0 motor is five times more efficient than a 4-stroke 20 horsepower petrol outboard, with an energy usage equivalent to less than 1 litre per hour at full throttle.



Input power: A performance indicator used for electric motors. Does not take system loss into account

Shaft power: A power rating used for combustion engines. Does not take propeller losses in to account, which can be anywhere from 20% to 75% of total power.

Propulsive power: The performance indicator used by commercial ships and by Torqueedo. Takes all losses into account and clearly indicates actual power delivered.



Horsepower equivalent

Electric motors can achieve the same propulsive power as combustion engines with significantly lower shaft power because of the different torque curves they produce. Electric motors deliver ample torque, which is available at any rotational speed. This characteristic allows them to turn large, efficient, high-pitch propellers that would cause an equivalent combustion engine to stall at startup. At Torqueedo, we always compare the actual propulsive power of our motors versus petrol engines. A Torqueedo motor specified as a "5 HP equivalent" provides the same power as a 5 HP combustion engine, even though its shaft and input power may be lower.

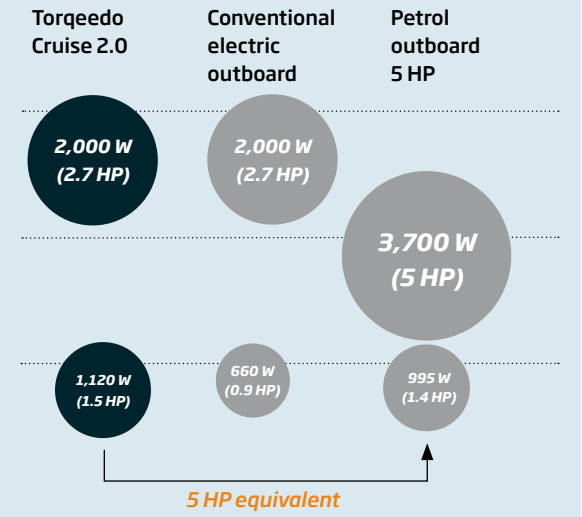

Convenience and predictability

What to expect when you switch to electric

Charging is clean and easy

Reducing your carbon footprint is convenient, too. Cruise- and Deep Blue-powered boats simply plug in to shore power. As no explosive or toxic fumes are emitted, you can fuel up while loading passengers or freight. High-capacity batteries equipped with fast chargers or multiple chargers reduce the charge time for a single Deep Blue battery from 0-75% to as little as 1.5 hours. Efficient and durable solar panels can be installed on the vessel or the docking area for 100% renewable charging, making your operation fully emission-free.

No more guesswork. Know what it takes to fill up

Highly volatile fuel prices are driven by changes in crude oil production and demand fluctuations, complicated by regulatory changes, tariffs, pressure from emerging markets and geopolitical instability. These global forces, or something as simple as a refinery or pipeline problem, can affect the overall profitability of your business.

While electricity prices do fluctuate, they are much lower and more stable than fuel prices. When you go electric, you stabilize your operating expenses and insulate your operation from the tumult of global crude oil markets.

Average retail fuel prices in the USA

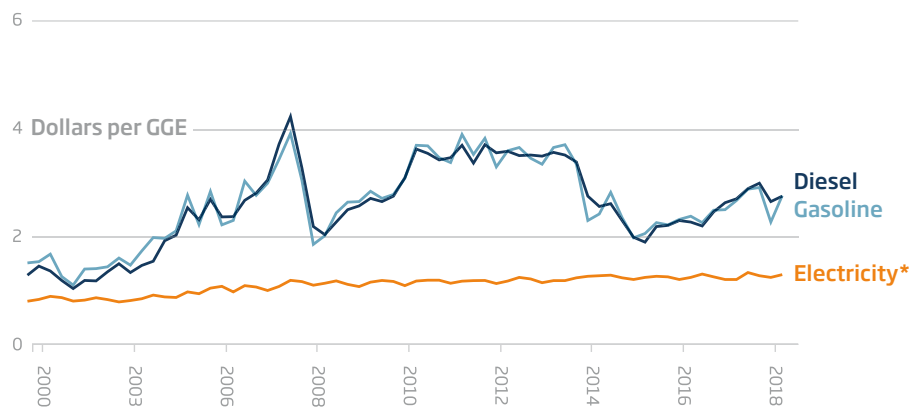

Source: Clean Cities Alternative Fuel Price Reports

Notes: Fuel volumes are measured in gasoline-gallon equivalents (GGEs).

* Electric prices are reduced by a factor of 3.4 because electric motors are 3.4 times more efficient than internal combustion engines.



Advanced engineering

No other electric boat motor manufacturer boasts such in-depth systems development, as many patents or as much capacity for innovation as Torqeedo

Optimised components

A high-performance system requires high-performance components. Torqeedo employs in-house industrial engineering for all technologies required for electric mobility. All components are either developed by us or carefully selected to complete our systems.

A poorly designed propeller may only deliver 20% propeller efficiency, yet an outstanding one up to 75%. Torqeedo propellers are perfected over several thousand iterations by the same methods developing propellers for container ships and submarines, a process called drive train engineering. When combined with automotive-grade batteries and bespoke electronics and controls, you have superb building blocks for electric propulsion. But it's not a Torqeedo system yet.

We still must achieve an intelligent interaction between the individual components and create a system that is safe, does its job and delights the user. Only then have we created a true Torqeedo product. This systems-based approach is at the centre of everything we do.

Seamless integration

Our software engineers ensure that all the high-tech features of Torqeedo's motors, such as real-time range calculations, smartphone integrations, adaptive charging and battery safety protocols, work properly. Coding and testing can account for more than 50% of the development work for today's electric propulsion systems, depending on the system's complexity.

Torqeedo engineers develop data networks which allow different components to communicate with one another quickly and seamlessly; the system constantly exchanges status messages, integrates sensor data and evaluates the appropriate course of action in a matter of milliseconds. Software stops the motor if it senses an impact on the propeller and manages battery charging safely. All Torqeedo motors have a GPS receiver built in that constantly measures speed over ground. With speed data, together with how much power the motor is using, the displays show real-time range and runtime estimates. You never need to worry whether you have enough energy left to get the job done.

Prepared to drive the future

The most complex Torqeedo systems for commercial applications simply wouldn't work without precisely manufactured components and painstakingly programmed software. With these bigger and more complex applications, it is Torqeedo's responsibility as the world leader in marine electric drives to drive innovation and system development to the next level.

That's why we put so much effort into the development and preproduction process - from planning and design to final testing. Torqeedo's quality management system is ISO 9001-certified with DNV-GL and our 230 international patents for electric boating speak for themselves.

Besides rigorous endurance tests and electromagnetic compatibility testing, Torqeedo has almost 40 test benches operating just in our German headquarters outside Munich. These benches perform comprehensive and long-term testing, as well as specific tests for gaining additional product- and project-specific approvals - achieving or surpassing the highest quality standards in the maritime sector.

How we work: facts and figures

230

international and multinational patents held by Torqeedo and covering all components and systems of electric boat motors.

24,000

calculations per millisecond performed by the processor in the Torqeedo Travel 1103 motor. The computing power significantly improves motor response.

40

lab benches for endurance testing and certifying compliance with international standards located in the German Torqeedo headquarters alone.

12%

of Torqeedo's turnover invested in research and development every year - a Silicon Valley level.

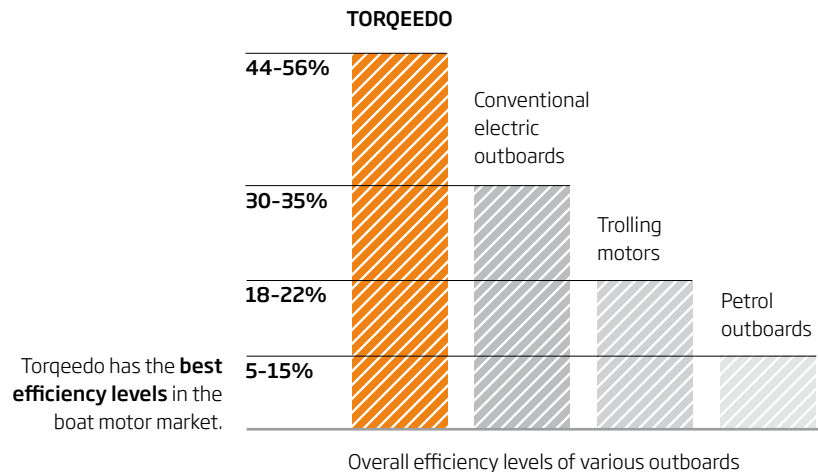

Since 2017, Torqeedo is part of the DEUTZ Group, one of the world's leading independent suppliers of diesel and natural gas engines.

A global support crew

Torqueedo's worldwide network of service partners and remote technicians, available around the clock to keep your business moving

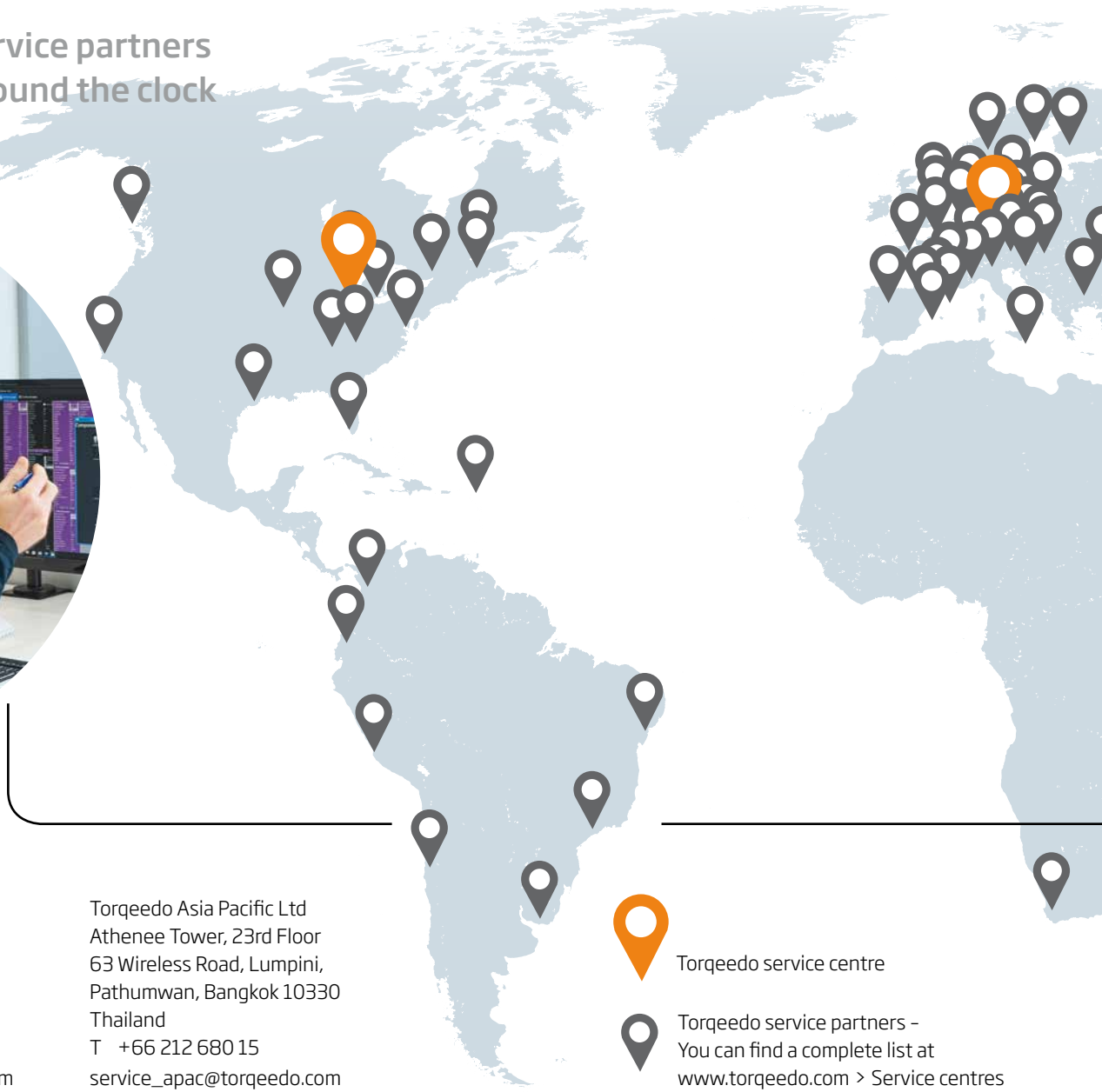

Torqueedo service centres

Torqueedo GmbH
Friedrichshafener Str. 4a
82205 Gilching
Germany
T +49 (0) 8153 - 92 15 - 126
F +49 (0) 8153 - 92 15 - 329
service@torqeedo.com

Torqueedo Inc.
171 Erick Street, Unit D-2
Crystal Lake, IL 60014
USA
T +1 - 815 - 444 8806
F +1 - 815 - 444 8807
service_usa@torqeedo.com

Torqueedo Asia Pacific Ltd
Athenee Tower, 23rd Floor
63 Wireless Road, Lumpini,
Pathumwan, Bangkok 10330
Thailand
T +66 212 680 15
service_apac@torqeedo.com



Torqueedo service centre



Torqueedo service partners -
You can find a complete list at
www.torqeedo.com > Service centres

The advantages



Remote diagnostics and service

Wirelessly connect the Deep Blue system with Torqeedo specialists for remote updates and diagnostics. Many hardware and software issues can be efficiently addressed. If First Response Kit is on site, downtime is minimised.



Experts on call

Torqeedo technicians and local service partners are ready to answer questions about your Torqeedo system.



E-mail an engineer

Our technicians and engineers will provide remote support and advice at your convenience. E-mail is a great way to schedule preventive and system maintenance appointments.



Torqeedo Service

Fast-response on-site service is available with a Premium Service agreement. A Torqeedo technician will arrive at your place of business within 18-48 hours.



Deep Blue and Deep Blue Hybrid

Performance, convenience and professional safety through industrial engineering and production: Deep Blue is a turnkey propulsion and energy management system from a single source.

- + Motors up to 100 kW are available in a high-rpm version for planing boats and low-rpm for displacement vessels
- + Upgraded 40 kWh batteries deliver the latest in automotive technology, adapted for marine use
- + Industry standards set for production quality and safety systems
- + Modular design - select from 100% electric or hybrid system with automatic generator backup
- + International service network
- + Remote monitoring, diagnostics, and updates

100 kW
136 HP*

50 kW
80 HP*

25 kW
40 HP*

- Water taxis
- Ferries
- Tour boats
- Lifeboats
- Research vessels
- Boats in protected or urban waters



Powerful electric performance

Torqeedo offers clean, efficient and powerful Deep Blue electric drives in three configurations and in three power classes: 100 kW, 50 kW and 25 kW.

Deep Blue 100 i 900 is a robust direct-drive motor that delivers the low rotational speeds necessary to efficiently power heavy displacement vessels. With 100 kW of continuous, emission-free power and over 1,000 Nm of torque, Deep Blue reduces maintenance and fuel costs, keeping you on budget and your business on the move. Fast planing workboats and vessels with lower power requirements can also meet their emission-free match with Deep Blue.

Wondering which motor is right for your application? Contact us - we're here to help.

> 12 g

The shock force boats may experience in heavy seas. Torqeedo designed the first shock protection device for lithium batteries in the marine industry.



Deep Blue 100 i 2500



Deep Blue 100 i 900



Deep Blue 25/50 i

1.5 hours

The Deep Blue battery can charge up to 75% capacity in as little as 1.5 hours when adequate shore supplies are available.



Deep Blue 25/50 R

1,000 nm

of torque is available to power your business when you choose Deep Blue 100 i 900.

100 kW
136 HP*

50 kW
80 HP*

25 kW
40 HP*

One fully integrated system

The modular, scalable, single-source solution

More than just a battery-powered electric motor, Deep Blue is a fully integrated propulsion and energy management system – customisable with modular components and industrially engineered to meet the highest demands. The result: exceptional performance and safety, compliance with international standards at the system level, and highly intuitive operation.

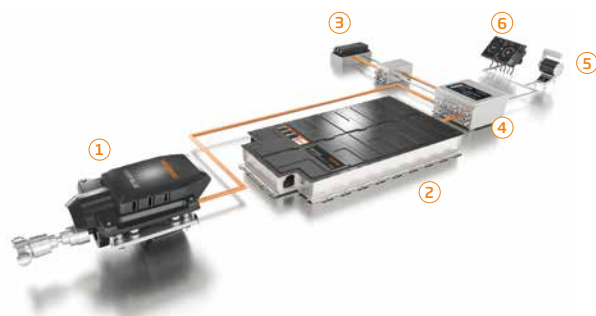

Deep Blue system

The essential Deep Blue configuration is suitable for vessels with access to shore charging and a priority on propulsive power. The system components, from propeller to high-tech user interface, are perfectly matched and integrated to provide emission-free, quiet and powerful propulsion.

- 1 Powerful electric motor
- 2 360 V high-capacity lithium battery system
- 3 Onshore power chargers
- 4 Drive connection box
- 5 Electronic throttle
- 6 Display with onboard computer

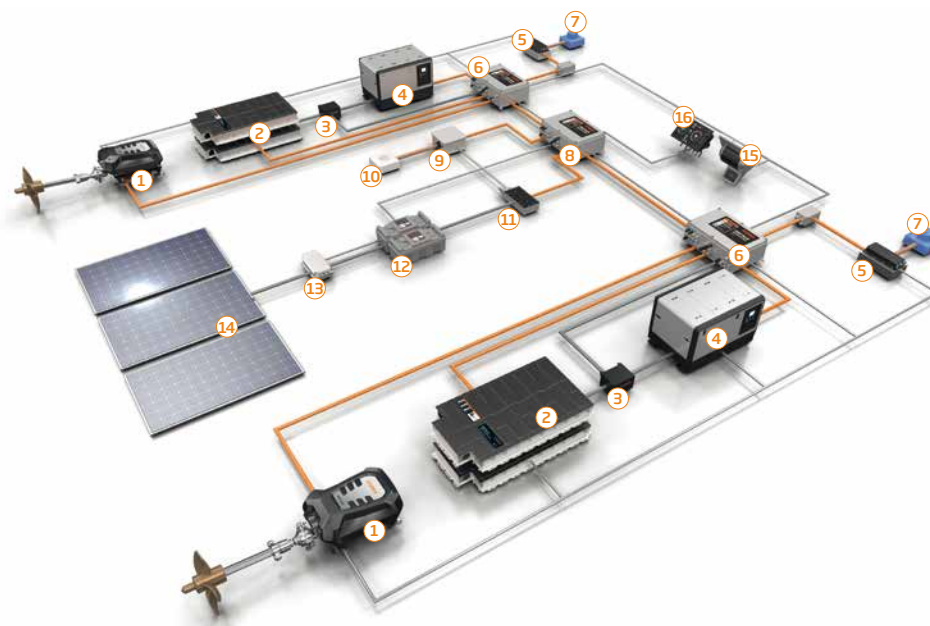

Deep Blue Hybrid system

This integrated, modular system is suitable for larger commercial vessels with complex onboard energy requirements or those that require longer range. Deep Blue Hybrid provides complete energy management – each component's power demands are monitored and managed by the central system, ensuring economical collection and distribution of solar power (if equipped), high-capacity lithium-ion batteries for energy storage and automatic generator backup.

- 1 Powerful electric motor
- 2 360 V high-capacity lithium battery system
- 3 12 V batteries
- 4 Efficient state-of-the-art diesel generator
- 5 Shore power chargers
- 6 System management unit
- 7 Shore power connection
- 8 System connection box
- 9 AC inverter
- 10 Isolated AC power system (120/240 V AC current, 50/60 Hz)
- 11 Bi-directional DC/DC converter
- 12 24 V on-board batteries
- 13 Solar charge controller
- 14 Photovoltaic modules
- 15 Electronic throttle
- 16 Display with onboard computer

Technical data

	DEEP BLUE 25 R	DEEP BLUE 50 R	DEEP BLUE 25 i 1400	DEEP BLUE 25 i 1800
Rated propeller speed	2,400 rpm	2,400 rpm	1,400 rpm	1,800 rpm
Shaftpower (continuous)	25 kW	50 kW	25 kW	25 kW
Shaftpower (peak)	30 kW	60 kW	30 kW	30 kW
Torque	198 Nm	198 Nm	343 Nm	280 Nm
Transmission	gearbox	gearbox	gearbox	gearbox
Weight (incl. electronics)	from 139 kg	from 139 kg	85 kg	85 kg



DEEP BLUE 50 i 1400	DEEP BLUE 50 i 1800	DEEP BLUE 100 i 900	DEEP BLUE 100 i 2500
1,400 rpm	1,800 rpm	900 rpm	2,700 rpm
50 kW	50 kW	100 kW	100 kW
60 kW	60 kW	-	120 kW
350 Nm	280 Nm	1,060 Nm	437 Nm
gearbox	gearbox	direct drive	direct drive
85 kg	85 kg	465 kg	195 kg



The power of Deep Blue: high-capacity lithium batteries with technology by BMW i

Industry-leading energy density, the latest automotive technology and highest safety standards

BMW i high-capacity batteries are available for boats. This technology, proven in thousands of BMW's innovative i3 automobiles, has been integrated into the Deep Blue system by Torqeedo.

The latest generation of automotive battery cells:

- Very high energy density
- Prismatic cell design allows efficient cooling, a compact form, even temperature distribution within the battery and an extremely rugged structure
- Robust protective aluminium housing with safety vent
- From the automated production process of Samsung SDI, a leading manufacturer of lithium battery cells

Laser-welded cell connections:

Over a larger surface and therefore stronger and more powerful than conventional spot-welded cell connections.

Pressure safety disc:

The battery is waterproof to IP67. In the unlikely event of excess pressure developing in a cell, the prismatic cells can release the excess pressure through a valve. This is a significant safety advantage over foil-welded cells and pouch cells. The pressure safety disc allows gases to escape and ensures the battery stays waterproof in normal operation.

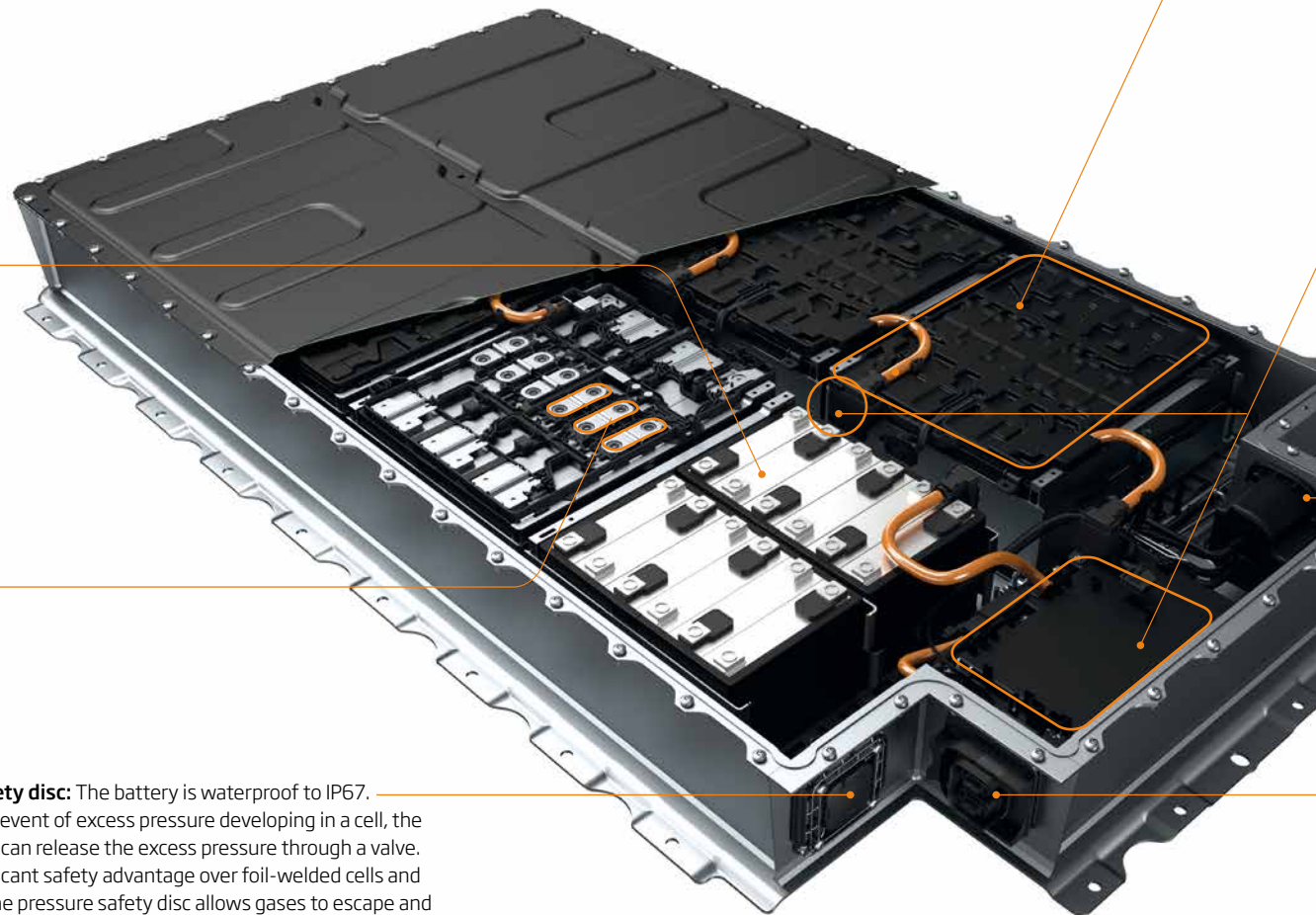

Automated module production:

- Prismatic cells have many advantages. However, they must be assembled extremely accurately in a very robust frame for a long service life. Otherwise charging and discharging would, over time, lead to the cells expanding and collapsing very slightly and cause them to age prematurely.
- The fully automated module production at BMW in Dingolfing has set the standard in high-precision and extremely robust battery modules.
- The very rugged design is ideal for boat applications that place high demands on shock resistance.

Battery management system (BMS) at module and battery levels:

- State-of-the-art BMS technology
- Developed to ASIL C standards as used in the automotive industry for maximum safety
- Qualification and acceptance testing at a far higher level than is typical in the boating industry

Compressor cooling: Cools the battery to ensure high performance and a long service life even in high ambient and water temperatures - in all climate zones anywhere in the world.

Power and data connections from the battery to the Deep Blue system

Professional safety features



The **insulation monitor** constantly monitors that the voltage from all 360 V components is completely isolated from the boat - not just for individual system components but for all of them. If damage is detected, e.g. to the cable insulation, the system will issue an alert. In the event of dangerous insulation failure, the system will be shut down.



The **pilot line** monitors all 360 V cable connections on the Deep Blue. It will shut off the system immediately if it detects exposed high-voltage contacts in order to avoid any risk. Pilot lines are mandatory safety features for high-voltage equipment in other industries. They are not typically found in high-voltage, made-to-order boat drives.



Automotive industry-level battery safety: The first lithium batteries for the marine industry with the advanced quality standards of the automotive sector are the result of Torqeedo's collaboration with established battery manufacturers. Integrating a battery into a drive system and the associated safety concept alone requires considerable effort that can only be achieved by working together with the battery manufacturer.



All components are waterproof: Components that were not specifically developed for boats are not always waterproof. All the components of a high-power system on a boat must be waterproof to guarantee safe operation. That is why all of our components are waterproofed and, in some cases, are further protected with water sensors.



Battery venting: In the unlikely event that the redundant safety mechanisms of the battery fail, the battery cells can reduce their temperature and pressure via a pressure valve. While batteries are installed in electric cars in such a way that they can discharge battery gases directly onto the road, on electric boats the gases must be channelled safely off the vessel. We developed the first safe venting system for boats for the Deep Blue system.



Battery damping: All components on fast and seagoing boats are subject to constant high levels of shock that exceed shock levels on the road - in some cases over 12 g of acceleration force. The same holds true when trailering the boat. Since batteries and battery electronics are not designed for these constant impacts, they need their own damping system on boats (in addition to the damping mechanisms within the battery). Torqeedo is the only company in the world that provides this for maritime use.

The perfect powerhouse



Deep Blue battery

The latest battery technology from the BMW i3 series: high energy density, long service life, robust, and built to the highest standards of quality and safety. With 40 kWh of usable capacity, the Deep Blue battery provides plenty of power for a full day on the water and paves the way for all sorts of new Deep Blue applications.

Technical data Deep Blue battery

Nominal voltage	360 V
Max. continuous performance	55 kW
Capacity	40.0 kWh
Weight	278 kg
Dimensions	1660 x 964 x 174 mm

Integrate a range extender

Automatic, efficient backup power

Deep Blue makes it easy to add and manage a range extender for seamless backup power. AC generators up to 60 kW can be integrated into your Deep Blue energy management system, or choose ultra-efficient DC generator input managed via the new DC interface for maximum convenience and safety. Check on your energy balance at a glance, set charging parameters, maintain state of charge, or explore ultra-convenient options like Night Mode, which ensures batteries are fully charged by the time you are ready to get to work.

Deep Blue DC interface

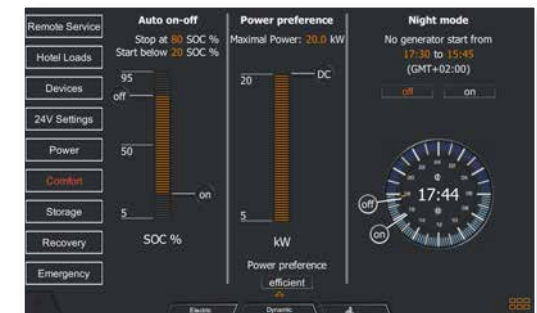



Climate-friendly coach boat



The electric propulsion allows the coaches to act as green and environmentally friendly as the athletes.

Tornado Boats offers a climate-friendly coach boat for sailing clubs, the Tornado 6m ZERO-E, in response to World Sailing's Challenge 2024 which aims to reduce the sport's climate impact. World Sailing's research indicates they will reduce their carbon footprint by 30% simply by switching the support vessels to alternative drive systems. Lars Hjorth, an avid sailor and owner of legacy rib (rigid inflatable boat) manufacturer Tornado Boats, decided to take up the challenge and built a zero-emission 6-metre RIB powered by Torqeedo's Deep Blue 50 R outboard and a 40 kWh Deep Blue battery.

"The performance of the boat is in many ways very much the same as if it was powered by a 70hp petrol outboard engine. Our aim was to get exactly this - a boat that performs like a "normal" coach boat and doesn't feel limited by the propulsion system," said Hjorth.



1 x Deep Blue 50 R



1 x 40 kWh Deep Blue battery

Main advantages



RIBs became popular for coaching in the early 1990s because their inflatable tubes act as giant fenders, allowing the coaches to closely approach the sailing dinghies during practice sessions without risking damage. Taken together with official boats and other harbour support boats, yachting clubs have become a significant market for RIB manufacturers like Tornado.

The boatbuilders at Tornado Boats modified a RIB to fit the Deep Blue system's battery, recessing the suspension system into the hull and manufacturing a custom battery cover which included the seats in the boat, and a compartment for the cooling system and system management unit.

Keeping plastic out of our oceans



The Deep Blue electric motor provides the low-speed torque and maneuverability needed to capture debris from the water while emitting no noise or exhaust fumes.

The Waste Cleaner 66 - billed as the world's most powerful all-electric boat designed for cleaning up pollution in inland waterways and harbours is powered by a Torqeedo 25kW Deep Blue motor with a 40 kWh Deep Blue battery, which provides up to eight hours of endurance at a cleaning speed of two knots

The six-meter (20-ft) aluminum boat, built at EFINOR's shipyard in Paimpol, uses patented technology to retrieve up to 700 kg (1543 lb) of solid waste and 1,000L (263 gal) of liquid waste, including hydrocarbons. The patented clean-up system automatically separates water and hydrocarbons to eliminate emulsification.



1 x Deep Blue 25 SD



1 x Deep Blue battery

Main advantages



The boat is designed for operation in inland waterways, harbors and coastal waters, including jetties and tight corners where access is difficult. The versatile platform can conduct suction at halt or when moving, either forward or in reverse. It can be trailered for road transport and has a single point of lifting for easy launching and recovery.

"We believe that acting locally is acting sustainably," said Benjamin Lerondeau, CEO EFINOR Sea Cleaner. "Our teams have worked closely with Torqeedo's engineers to create a highly efficient climate-neutral platform that meets the needs of harbors and marinas to maintain clean water while reducing their environmental impact."

Saving lives with Deep Blue



Photo credit: Mats Ryde



2 x Deep Blue 50 i



2 x Deep Blue batteries

Main advantages



Swedish Sea Rescue Society chose a Torqeedo battery-electric propulsion system for a dual-mode rescue boat.

The boat is the first-ever in the Sea Rescue Society's fleet to have parallel diesel and electric motors. The electric drive system consists of dual Torqeedo Deep Blue 50KW electric motors for a with two Deep Blue lithium batteries. The vessel can operate silently and emission-free up to 1.5 hours between recharges at a search speed of 6 knots.

The Swedish Sea Rescue Society is a non-profit association that saves lives at sea. There are 2,200 volunteer seafarers ready to take off in all kinds of weather, all year round. The Society also works to prevent accidents by spreading information and knowledge about maritime safety.

"We use the electric mode when entering and leaving port through Sweden's environmentally sensitive waterways," said Lars Samuelsson, head of the Maritime Department. "The crew uses the diesels for high-speed runs out to the rescue location, then switches back to electric for search and rescue operations. It is crucially important to go quietly on the job since even the smallest sound can hinder the search for a missing person in the water."

The 14-metre (46-ft) composite vessel, christened Rescue Mercedes Eliasson Sanne, carries a crew of three or four people for rescue missions. It operates out of the Rörö rescue station in Gothenburg's northern archipelago.

Hybrid-electric autonomous vessels



"Torqeedo gave us the level of engineering and system integration support needed to create a fully meshed propulsion and control solution to meet our requirements for autonomous survey operations." *Don Darling, SeaRobotics*

Dependable performance, extended time on station and quiet operation are key criteria when conducting acoustic underwater surveys. That's why SeaRobotics selected an electric propulsion system from Torqeedo for their Endurance 7.0 autonomous surface vessel (ASV).

"Our power requirements for this Endurance 7.0 ASV were very specific," said Don Darling, president of SeaRobotics. "The vessel required extended endurance on station as well as a quiet operating mode while performing acoustic research operations."

The powertrain for the seven-meter (23 ft) aluminium boat consists of a Torqeedo Deep Blue 50i electric motor, a 360 VDC 30.5 kW lithium propulsion battery, a water-cooled DC-DC converter, a 24 VDC lithium battery for DC-DC

backup, and a 25 kW diesel generator. The fully integrated computer-controlled propulsion system is designed for long-range unmanned hydrography and subsea mapping missions.

The system is designed to provide up to six days on station at survey speeds and up to 10 hours between automatic battery recharges from the onboard generator. The recharging cycles are fully automatic under computer control.

"The DeepBlue electric drive, with 80 horsepower-equivalent output, provides ample power for a wide range of towed or statically deployed systems," Darling said. "In addition, the smooth, continuous and rapid transition from forward to reverse thrust assists in station-keeping as well as near-dock manoeuvring."



1 x Deep Blue 50 i



1 x Deep Blue battery

Main advantages



Electric freefall lifeboat from Verhoef

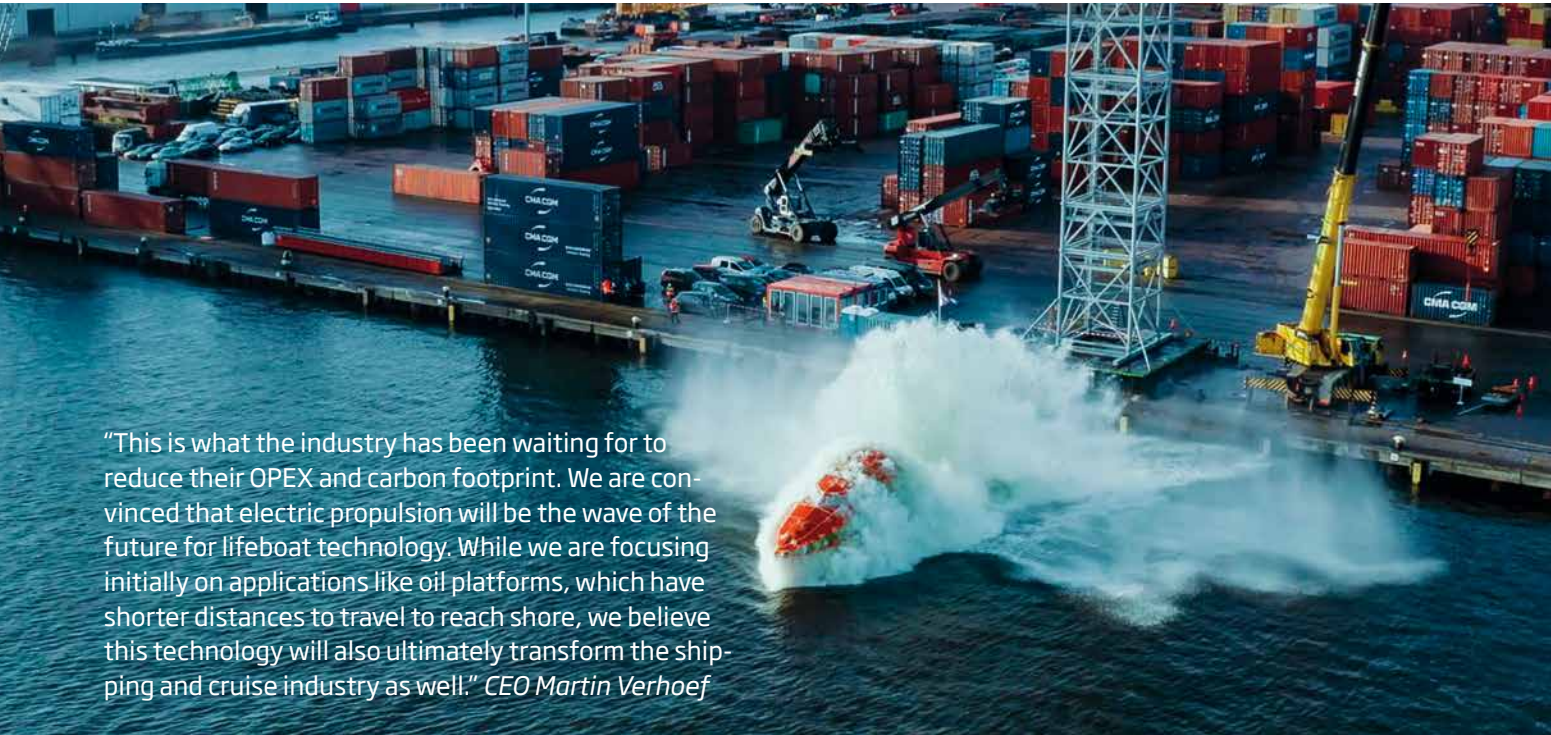

“This is what the industry has been waiting for to reduce their OPEX and carbon footprint. We are convinced that electric propulsion will be the wave of the future for lifeboat technology. While we are focusing initially on applications like oil platforms, which have shorter distances to travel to reach shore, we believe this technology will also ultimately transform the shipping and cruise industry as well.” *CEO Martin Verhoef*

Torqueedo provided the integrated propulsion system for the world’s first electric-powered freefall lifeboat, which is being built by the Dutch builder Verhoef. The vessel recently passed its final drop tests, making it the first fully functional electric lifeboat in the world.

The first of the new Verhoef aluminium 32-passenger lifeboats will be deployed on an offshore platform in the new Valhall Flank West oilfield project in Norway.

Verhoef and Torqeedo engineers have developed and tested a fully integrated emission-free propulsion system consisting of a 50 kW, 80 horsepower-equivalent, Deep Blue inboard electric motor powered by three 30.5 kWh Deep Blue batteries with technology by BMW i. The rugged system is designed to with-



1 x Deep Blue 50 i



3 x Deep Blue batteries

Main advantages



stand the heavy g forces of freefall launch and provide 30 minutes at full speed, followed by 10 additional hours at 50% of maximum speed.

Diesel lifeboat engines require a great deal of ongoing maintenance and repairs. Soot accumulation in the seldom-run engines can cause internal damage and negatively affect the performance and reliability of the evacuation system.

Verhoef estimates that the electric propulsion system will reduce operating costs by about 90 to 95% compared to combustion-powered lifeboats. The built-in connectivity function will enable remote monitoring of the condition of the electric system from shore, making sure this critical equipment is always ready to go.

UNESCO site boasts eco-friendly tours

“Torqeedo’s high-power Deep Blue system was the obvious choice to propel Canada’s largest electric passenger vessel because of its comprehensive safety systems,” says Robert Taillefer, the owner of *Queen Elizabeth Dr.* and operator of Ottawa Boat Cruises

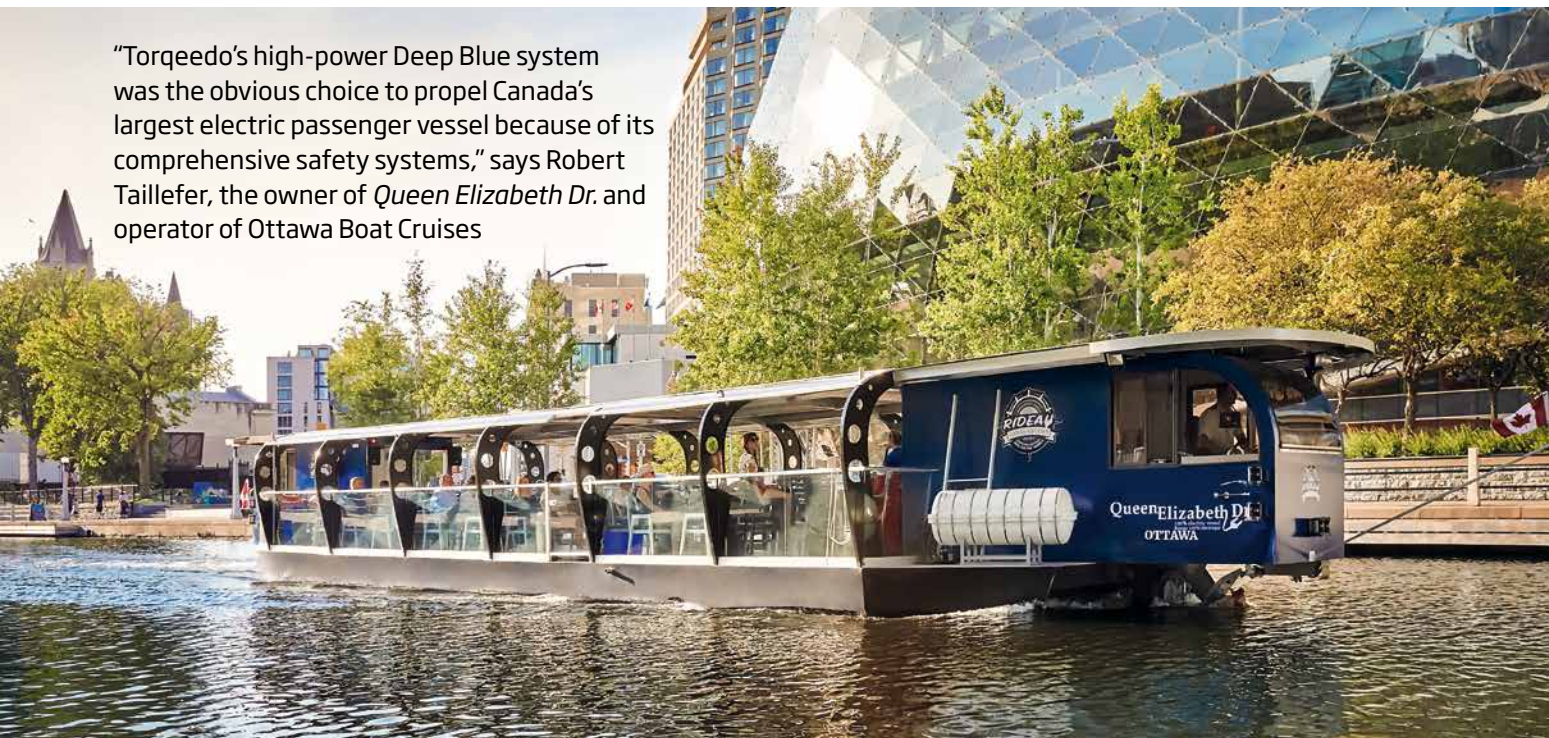

2 x Deep Blue 50 R



8 x Deep Blue batteries

Main advantages



The largest 100% electric passenger boat in Canada, the *Queen Elizabeth Dr.* launched in 2016 in Ottawa, the nation’s capital city. The 75-foot, 100-passenger vessel provides an environmentally friendly tour of the historic Rideau Canal. The waterway is the oldest continuously operated canal system in North America and is a UNESCO World Heritage Site.

The *Queen Elizabeth Dr.* has two 50 kW Deep Blue outboard systems installed but uses only one at a time. The canal is quite narrow and the boat is long; instead of turning around the operator simply walks to the opposite end of the vessel and uses the second system for the return trip.

Robert Taillefer, owner of Ottawa Boat Cruise, operates the electric tour boat along with several combustion-powered vessels. The Deep Blue systems cost approximately US\$ 90,000 more to purchase than equivalent diesel engines

but Taillefer estimates that the electric drives save the company \$26,000 per year in reduced fuel and maintenance costs, resulting in a break-even point of 3.5 years.

Ottawa’s Riverkeeper, Meredith Brown, was pleased to see a new electric powered tour boat in the city. “Our organization is always happy to see new opportunities for people to connect with the river in a sustainable way,” says Meredith Brown, “and there is nothing like a quiet electric motor to help everyone enjoy the natural sounds of the river.”

The Canadian capital city is familiar with the benefits of electric boating – a Torqeedo-powered water taxi has served the downtown area for several years. When Parks Canada opened an opportunity for a new tourism operation within the canal, it specified that only electric boats would be considered.

German electric workboat for heavy loads

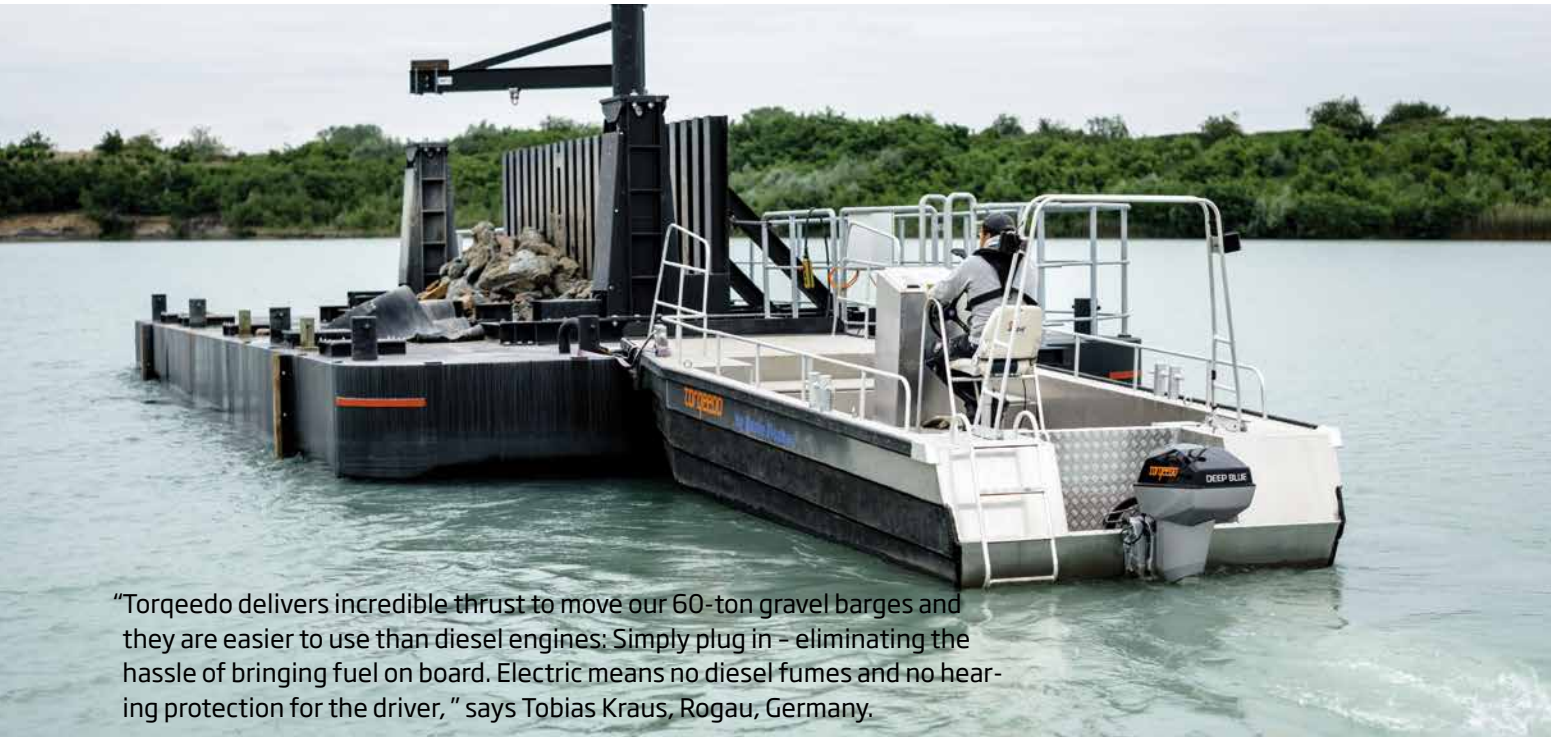

“Torqeedo delivers incredible thrust to move our 60-ton gravel barges and they are easier to use than diesel engines: Simply plug in - eliminating the hassle of bringing fuel on board. Electric means no diesel fumes and no hearing protection for the driver,” says Tobias Kraus, Rogau, Germany.



1 x Deep Blue 50 RL



2 x Deep Blue batteries

Main advantages



In order to protect the local groundwater, the Kaspar Weiss gravel quarry equipped their workboat with the zero-emission Deep Blue system.

At the Rogau site near Frankfurt, Germany, the quarry yields countless tons of gravel annually. However, this commercial extraction of gravel results in vast amounts of useless byproducts such as sand, mud, clay, and rocks. With the help of a workboat and barge, these byproducts are removed. Launched in 2015, the fully electric vessel easily manoeuvres the fully loaded barge, removing over 700 tons of material from the quarry lake every day.

The powerful Deep Blue 50 kW outboard propulsion system is a true work-horse, well-suited to applications involving heavy loads. It delivers a propulsive power equivalent to an 80hp petrol outboard and operates at an overall efficiency of 54%. Deep Blue 50 R achieves a static thrust of up to half a ton and the high torque required to spin a large propeller, generating sufficient thrust at low rpm to move these tremendous loads. The system's lithium batteries store a total of 26 kWh of electrical energy, more than enough power for a full day's work.

Award-winning Spanish solar ferry



2 x Deep Blue 50 i



8 x Deep Blue batteries



Solar

Main advantages



The ECOCAT is an 18-metre, 120-passenger ferry which runs on 100% solar-electric power - with no auxiliary combustion engine. The ferry is part of the Mar Menor fleet in southern Spain, an ideal climate for a fully solar vessel. Deep Blue's energy management system manages all onboard energy consumers and clean power production via 40 kWp of roof-mounted solar panels. The ferry is propelled by two 50 kW Torqeedo Deep Blue electric motors and eight Torqeedo 30.5 kWh high-capacity batteries with technology by BMW. Torqeedo received the prestigious Maritime Sustainability Award from the European Commercial Marine Awards (ECM) for its contributions to the development of the ECOCAT, which was built by Metaltec Naval Shipyard and designed by m2 Ingenieria Naval.

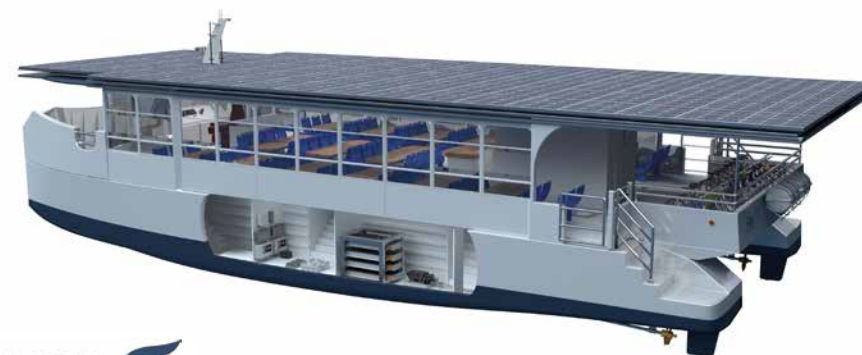

Eco-tours in Vietnam theme park



1x Deep Blue 50 i



1 x Deep Blue battery

Main advantages



A fleet of 15 Deep Blue-powered passenger excursion boats are used for sightseeing tours of the River Safari jungle habitat at Vinpearl Land Nam Hoi An, a massive theme park in Hoi An, Vietnam, as well as for entertainment in the park's replica of the world-famous Hoi An Ancient Town.

The whisper-quiet electric boats allow guests to get close to the rare animals that live in the River Safari without disturbing their natural behavior. The theme park and resort has significantly lowered operating costs and improved their guests' onboard experience with no engine noise, vibration or exhaust fumes.

The nine-metre fibreglass boats are powered by a 50 kW Deep Blue inboard motor and one high-capacity lithium battery and operate at an average sightseeing speed of 3 knots.

The vessels were purpose-built by Song Lo Shipbuilding Company for the new Vinpearl resort development. Vinpearl is the largest hospitality group in Vietnam, operating a chain of luxury hotels, villas and theme parks across the country.

Electric workboat from France



1 x Deep Blue 50 RXL



1 x Deep Blue battery

Main advantages



Marinas, ports and harbours around the world are looking for ways to lower operating expenses and their carbon footprint. The brand-new ZenPro 580, a 5.8 metre workboat purpose-built for electric propulsion, is making it easy.

The 580's lightweight but durable aluminium hull and Hypalon tube design weighs just 350 kg, which allows the 50 kW Deep Blue outboard and lithium battery (i3 type) to propel the RIB at up to 25 knots.

The open, flexible deck design of the ZenPro 580 allows it to be configured as more than a work platform. The RIB can also carry up to eight passengers for emission-free excursions from cruise liners operating in sensitive natural areas.

The ZenPro 580 is built in France by the electric boating experts at Naviwatt. The company also offers two ultra-efficient catamaran-style vessels powered by Cruise outboards for use on inland or protected waters.

Cruise and Travel

Proven reliable low-voltage electric drives are ideally equipped to meet the challenges of everyday use



SEA PROVEN
Revue *Marine & Océans*
www.marine-oceans.com

- + High-torque and eco-friendly
- + Low-voltage for easy handling
- + Durable and robust design
- + Latest battery technology
- + Solar charging compatible

10 $\frac{\text{kW}}{20 \text{ HP}^*}$

4 $\frac{\text{kW}}{8 \text{ HP}^*}$

2 $\frac{\text{kW}}{5 \text{ HP}^*}$

1 $\frac{\text{kW}}{3 \text{ HP}^*}$

Water taxis
Passenger ferries
Rental boats
Commercial boats up to 10 tons



Cruise motors in action for whale research

This unmanned research vessel tracks the song of sperm whales, who spend 90% of their time submerged at great depths. Sea Proven, the French robotics company, chose Cruise pod motors for this mission because their almost-silent operation improves the quality of the recordings captured by the drone's hydrophones and doesn't disturb the natural behavior of these noise-sensitive creatures. The vessel is completely self-powered by renewable energy, with solar collectors and a small wind generator mounted on deck.



Emission-free outboards for easy operation

Since their premiere in 2006, Cruise motors have been the leader in low-voltage e-mobility systems for commercial operations with power requirements between 5 and 20 HP equivalents. Cruise motors have a built-in GPS, with on-board computer and display for real-time speed and input power, state of charge and remaining range, even with third-party batteries. They have a robust, low-maintenance design that's waterproof to IP67, pylons made from aluminium and a specially reinforced fin. They

team up with the purpose-developed propellers and additional Torqeedo components to create a highly impressive package. The flagship remote outboard model in the Cruise series, the Cruise 10.0, (20 HP equivalent), received a technical update for the 2021 boating season. It now comes standard with Torqeedo's advanced communication system, TorqLink, which allows faster and more accurate data sharing between system components.



Introducing TorqLink

TorqLink is Torqeedo's advanced electronics communication system developed for Deep Blue and now available for select Cruise motors, throttles and Power 48-5000 batteries. All products marked TorqLink will communicate seamlessly at startup. A TorqLink Gateway (2217-00) allows you to include components without TorqLink in your system.



Cruise 2.0/4.0 T



Cruise 2.0/4.0 R



Cruise 10.0 T



Cruise 10.0 R

Update for
2021
available
in April



Ultra-quiet pod motors for discreet electric power

Pod motors install through the hull and are completely hidden from view, so rental fleets or commercial operations can harness the power of electric drives without compromising their vessels' classic good looks. Beautifully quiet and clean-running, Torqeedo pods deliver impressive performance and long range when paired with Torqeedo's lightweight lithium batteries (page 38). The built-in GPS, onboard computer and display take all motor, battery and charging data into account and display it clearly, providing a perfectly harmonised drive system.



New TorqLink throttle with colour display

With its bright, easy-to-read, colour display, this new throttle is the perfect control for your TorqLink equipped Cruise 10.0 system. It displays all critical system data at the push of a button and boasts infinitely variable forward and reverse in a high-tech design. It has Bluetooth built in for easy connection with TorqTrac, the Torqeedo smartphone app.



Cruise 2.0/4.0 FP

Cruise 10.0 FP

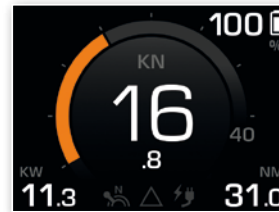

Drive screen:
Speed over ground



Range screen:
Energy efficiency and runtime

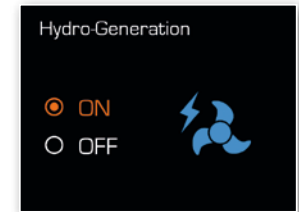

Setting example 1:
Hydrogeneration on/off

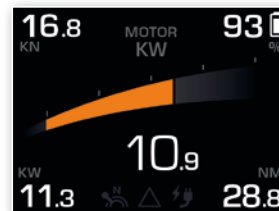

Power screen:
Energy consumption



Charging:
Charge rate and time to full



Setting example 2:
Screen brightness

Head for the horizon with Cruise Hybrid

Cruise Hybrid systems provide economical, complete power for your 25 to 40 foot vessel up to 10 tonnes. Tried and tested Cruise motors are matched with high-performance lithium-ion batteries from Torqeedo's Power series, a variety of charging options, and electronic throttles and displays - all connected with TorqLink, Torqeedo's advanced com-

munications protocol. Choose to view system data on your boat's NMEA 2000 multifunctional display, throttle display, or directly on your smartphone with the TorqTrac app.

Charge your batteries from shore power with our standard or fast chargers, or harness the power of

the sun with a smart solar charge controller and your onboard photovoltaics. Sailboats can even charge their own batteries while sailing - just place the system in hydrogeneration mode. For seamless backup power, you can integrate AC digital inverter generators up to 10 kW - visit torqeedo.com for technical details.

New for
2021

Solar Charge Controller for Power 48-5000

This smart solar charge controller keeps your Cruise with TorqLink and Power batteries system charged with free, green solar energy. The integrated MPPT maximises the energy yield of the solar modules during charging and eliminates passive losses by turning on the battery for charging only when solar power is available. Large solar arrays are now easy to integrate - connect up to 6 solar charge controllers in parallel with a peak input power of 325 W each.

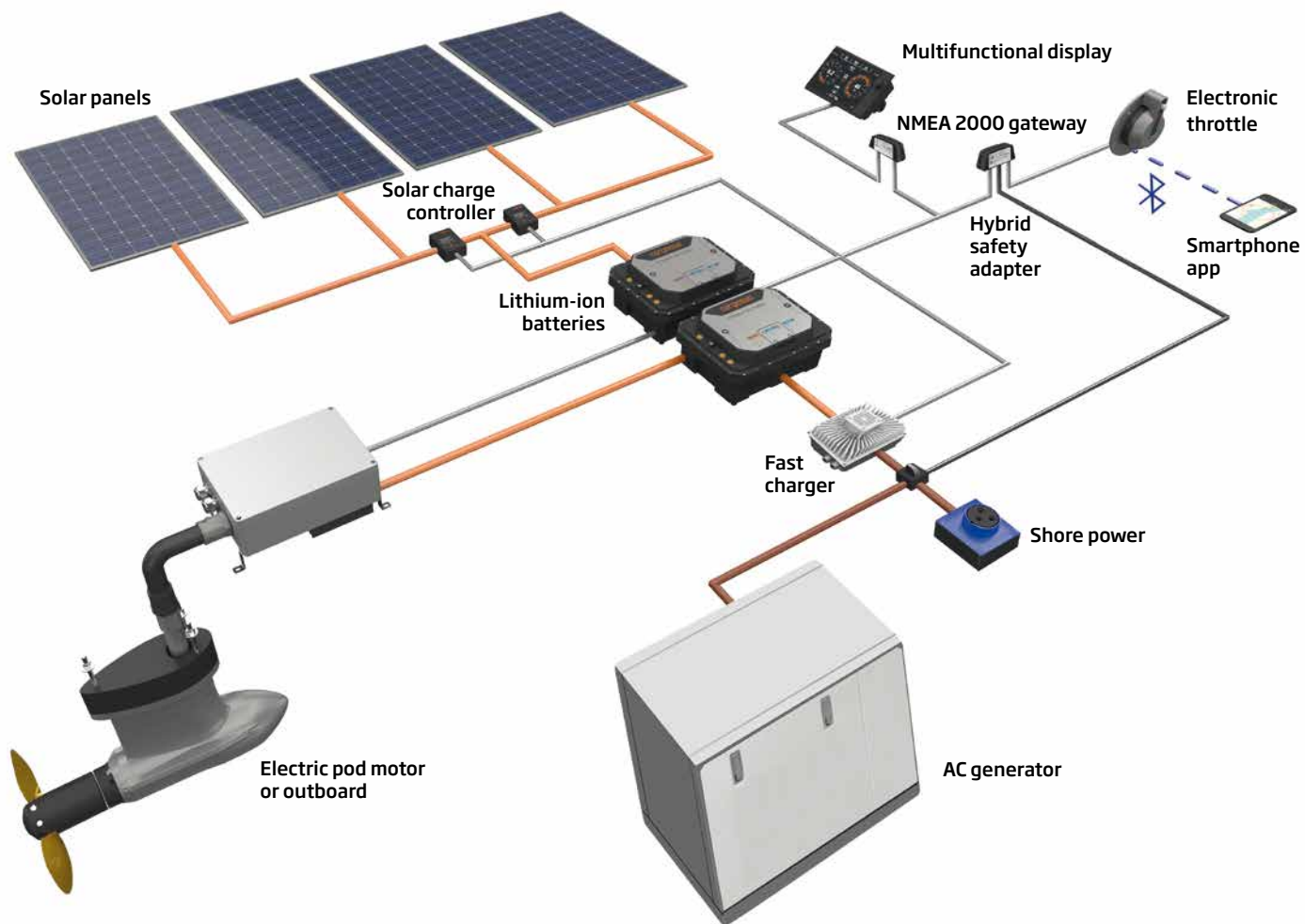

More throttles to choose from



Side-mount single



Top-mount single



Top-mount twin

Travel motors for boats up to 1.5 tons

The **top-of-the-line Travel 1103 C** is the flagship model in the globally successful Travel series, which has been successfully used in rental fleets, yacht clubs and other commercial operations since its launch in 2005. Featuring a direct-drive motor design, it is the **quietest motor in its class**, has an aluminium pylon for increased protection from impact damage and a **heavy-duty transom mount**. The Travel 1103 C has an integrated **high-performance 915 Wh lithium-ion battery** and a built-in onboard computer, with all the high-tech features your customers deserve. The Travel 603 is perfect for lightweight vessels, small boat rentals or charter operations. Its integrated 500 Wh battery is easy to swap out between rentals, so your customers always leave with a full charge.



0.6 kW
2 HP*

1 kW
3 HP*

Travel 603

Travel 1103 C

Technical data

	TRAVEL 603	TRAVEL 1103 C	CRUISE 2.0 T/R	CRUISE 4.0 T/R
Input power in W	600	1,100	2,000	4,000
Propulsive power in W	295	540	1,120	2,240
Comparable petrol outboard (shaft power)	2 HP	3 HP	5 HP	8 HP
Comparable petrol outboard (thrust)	2 HP	4 HP	6 HP	9.9 HP
Comparable diesel inboard (shaft power)	-	-	-	-
Comparable diesel inboard (thrust)	-	-	-	-
Maximum overall efficiency in %	49	49	56	56
Static thrust in lbs*	44	70	115	189
Integrated battery (Li-Ion)	500 Wh, floating	915 Wh	-	-
Nominal voltage in V	29.6	29.6	24	48
Final charging voltage in V	33.6	33.6	-	-
Total weight in kg	15.5	17.3 (S) / 17.7 (L)	T: 17.5 (S) / 18.6 (L) R: 15.3 (S) / 16.2 (L)	T: 18.3 (S) / 19.4 (L) R: 16.1 (S) / 17.0 (L)
Motor weight without battery, in kg	11.3	11.3 (S) / 11.7 (L)	-	-
Weight of integrated battery, in kg	4.2	6.0	-	-
Shaft length in cm	62.5	62.5 (S) / 75 (L)	62.4 (S) / 74.6 (L)	62.4 (S) / 74.6 (L)
Standard propeller (v = speed in km/h at p = power in W)	v10/p1100	v10/p1100	v13/p4000	v20/p4000
Alternative propeller options	v10/p1100 weedless	v10/p1100 weedless	v19/p4000 v20/p4000 v30/p4000	v13/p4000 v19/p4000 v30/p4000
Maximum propeller speed in rpm at full load	1,100	1,450	1,300	1,300
Control	Tiller	Tiller	Tiller/throttle standard	Tiller/throttle standard
TorqLink	no	no	no	no
Steering	+/-60° lockable	+/-60° lockable	360° lockable	360° lockable
Tilting device	Manual, with impact protection	Manual, with impact protection	Manual, with impact protection	Manual, with impact protection
Trim device	Manual, 4-step	Manual, 4-step	Manual, 4-step	Manual, 4-step
Stepless forward/reverse drive	yes	yes	yes	yes
Integrated onboard computer with display	yes	yes	yes	yes

* Torqeedo static thrust measurement is based on internationally accepted ISO standards. Static thrust figures for conventional trolling motors are typically measured differently, which results in higher values. To compare Torqeedo static thrust data with conventional trolling motors, add approximately 50% to the Torqeedo static thrust values.

** not included

CRUISE 10.0 T/R	CRUISE 2.0 FP	CRUISE 4.0 FP	CRUISE 10.0 FP
10,000	2,000	4,000	10,000
5,600	1,120	2,240	5,600
20 HP	-	-	-
25 HP	-	-	-
-	5 HP	8 HP	20 HP
-	6 HP	9.9 HP	25 HP
56	56	56	56
up to 405	115	189	up to 435
-	-	-	-
48	24	48	48
-	-	-	-
T: 60.3 (S)/61.8 (L)/63.0 (XL) R: 59.8 (S)/61.3 (L)/62.5 (XL)	15.4	15.8	33.5
-	-	-	-
-	-	-	-
38.5 (S)/51.2 (L)/63.9 (XL)	-	-	-
v22/p10k	v13/p4000	v13/p4000	v15/p10k
v32/p10k v15/p10k	v13/p4000 (folding propeller)	v13/p4000 (folding propeller)	v15/p10k (fold. prop.) v22/p10k v32/p10k
1,400	1,300	1,300	1,400
Standard (T)/TorqLink throttle (R)**	Throttle Standard	Throttle Standard	TorqLink throttle**
no (T) / yes (R)	no	no	yes
+/-45°	-	-	-
Power tilt	-	-	-
Manual, 4-step	-	-	-
yes	yes	yes	yes
yes	yes	yes	yes

(S) short version
(L) long version
(XL) extra-long version

Superior battery technology

Safe, powerful and easy to use - Power batteries are the ultimate energy source for Cruise motors or hotel loads

Lithium-based batteries are the technology of choice for electric mobility applications. They store significantly more energy than all other batteries, maintain a high current (a major advantage for electric drive systems), do not lose their charging capacity, supply power reliably even in cold weather and have no memory effect. They also provide many more cycles than lead-based batteries.

Torqueedo has been a pioneer in the development of lithium batteries for marine applications for more than a decade. Since we make our batteries just a little bit better each year, we offer the most comprehensive and integrated protection and safety concept for lithium batteries on the market - coupled with performance and convenience.

Intelligent battery management system (BMS)

The BMS **monitors and protects** Torqueedo batteries against overcharging, overcurrent, deep discharge, short-circuit and overheating. The battery has comprehensive safety features, and each safety-relevant component is duplicated with a backup component should it fail. In addition to these safety features, the BMS safeguards the battery's life expectancy with balancing and deep-sleep functionality.



Safe and easy to transport

Thanks to their **high energy density** the volume and weight of lithium batteries are more than 70% lower than comparable AGM or lead-gel batteries. This makes our low-voltage batteries simple to handle and light to carry. On top of that, Torqueedo Power and Deep Blue batteries can be switched on and off, allowing them to be safely **transported and installed** and protecting them against unintentional discharge.



High-quality safety cells

Several hardware mechanisms in every single cell provide additional safety. Torqeedo only uses cells based on lithium (Li-NMC) sourced from the **clean, precision production processes** of reputable manufacturers. In the case of the new Power 48-5000, the modules are produced by BMW i.

System communications

The battery electronics continuously communicate all the details of the battery status to the onboard computer.

Completely waterproof

Waterproof housing (IP67): While battery immersion should be avoided, all Torqeedo batteries are, without exception, completely waterproof. The waterproof characteristics of each battery are individually tested prior to delivery.

Waterproof connections: Whether connected or not, all cable connectors are completely waterproof to IP67.

Lithium battery safety

Besides performance, safety plays an important role for lithium batteries. In our view, five factors need to be considered in order to ensure that safe really means safe:

1. **Safe battery chemical engineering**, such as LiNMC (lithium nickel manganese cobalt oxide).
2. **Safe cell packaging:** Torqeedo uses only individually welded safety cells: either steel cylindrical or assembled into modules and equipped with multiple safety mechanisms. Other forms of packaging offer a lower standard of safety as they afford less effective protection against short-circuiting within the cells.
3. **Clean, precision production processes** on the part of the cell manufacturers: Torqeedo only uses cells and modules sourced from the most reputable brands in the world.
4. **Battery management system (BMS) with redundant safety features:** Unlike lead-based batteries, lithium batteries always need a BMS to perform balancing and safety functions. If electronic components of the BMS fail it can itself become a safety problem for the battery. That's why there is hardware backup for all safety-relevant components in Torqeedo batteries. Incidentally, this is also stipulated in the automotive industry, in aerospace and for medical technology.
5. **Waterproof to IP67:** Water in lithium batteries can lead to various problems such as corrosion of the BMS hardware or the creation of electrolytic gas. Lithium batteries on board a boat should, therefore, be waterproof.

Power play

The 24-volt Power 24-3500 delivers 3.5 kWh of power in just 25.3 kg for an impressive energy density of 138 Wh/kg. With the 1,700 W fast charger, you can fill up the Power 24-3500 in just under two hours, making this lithium pack perfect for the Cruise 2.0 motor or to power hotel loads on board. For boats powered by Cruise 4.0 or 10.0 motors, choose the 48-volt Power 48-5000 with TorqLink.



Power 24-3500

Technical data

	Power 48-5000	Power 24-3500
Useable energy	5,000 Wh	3,500 Wh
Nominal voltage	44.4 V	25.9 V
Weight	37.0 kg	25.3 kg
Energy density (weight)	135 Wh/kg	138 Wh/kg
Maximum discharge rate	200 A (8,880 W at nominal voltage)	180 A (4,500 W at nominal voltage)
Dimensions	506 x 386 x 224 mm	577.5 x 218.5 x 253.5 mm
Battery chemistry	Li NMC	Li NMC
Cycle lifetime	> 3,000 cycles at 80% depth of discharge at 25°C results in approx. 20% capacity loss	800 cycles at 100% depth of discharge at 25 °C results in approx. 25% capacity loss
Annual capacity loss	< 3%	< 4%
Max. connections	2P as shipped; contact us for more options	2S8P or 1S16P
TorqLink	yes	no
Price-performance	1 EUR/Wh	0.86 EUR/Wh



Power 48-5000



Power 48-5000

Bringing the latest electric vehicle technology to the marine market, the 48 V Power battery is in a class of its own with its combination of high energy density at a low cost per watt-hour, long service life and ISO standards compliance.

No fuel, no fumes

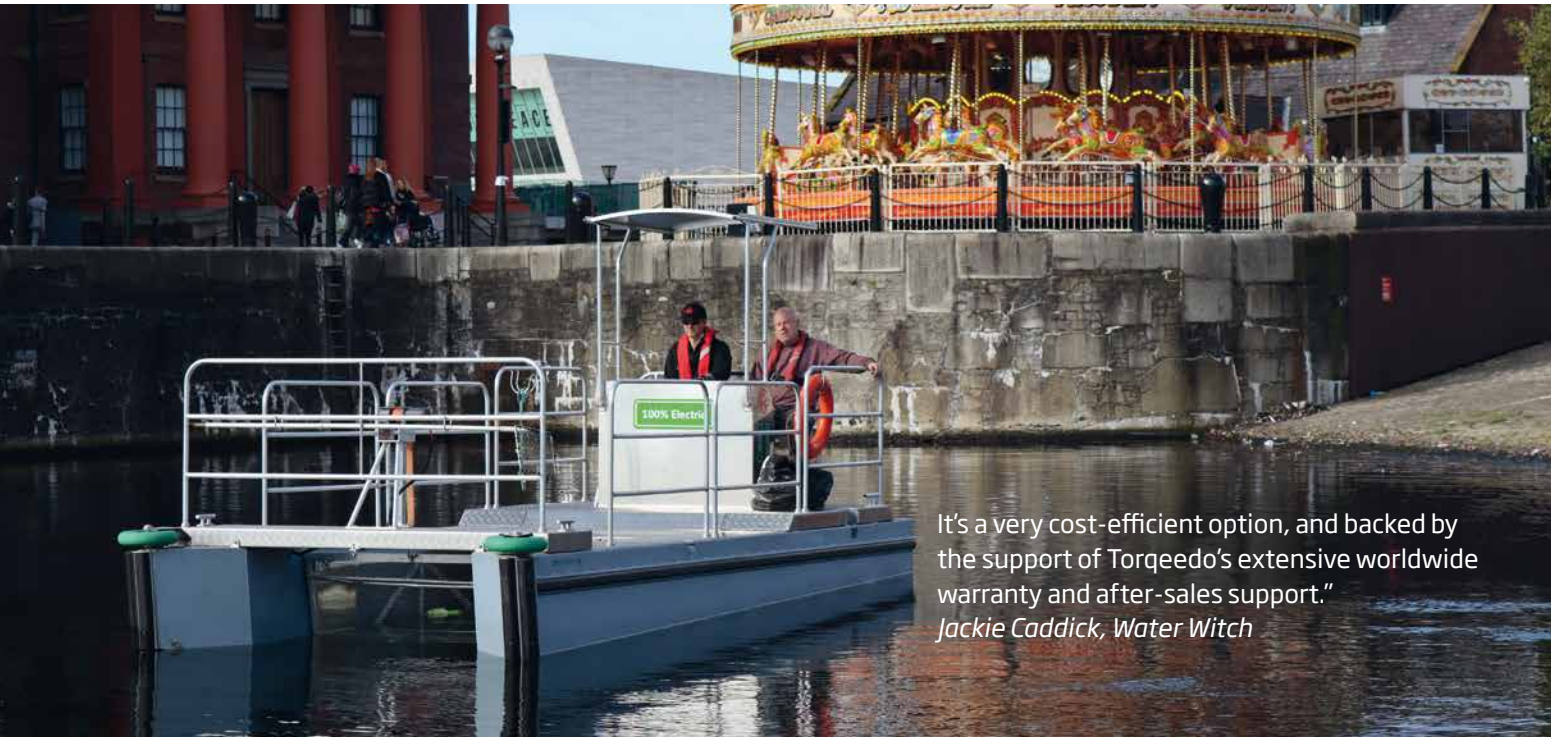

It's a very cost-efficient option, and backed by the support of Torqeedo's extensive worldwide warranty and after-sales support."
Jackie Caddick, Water Witch



1 x Cruise 10.0 R



2 x Power 48-5000

Main advantages



Water Witch fights ocean plastic pollution with electric clean-up boats.

Water Witch has been building specialised clean-up boats for over 50 years, with some 200 debris and trash retrieval workboats deployed in harbours and waterways around the world. The Liverpool-based boatbuilder now offers emission-free electric drives on its whole range of Versi-Cat litter collection craft and pontoon workboats.

"This is a clean, green, safe, zero-emission solution with long life, low maintenance and minimal operating costs," said Water Witch director Jackie Caddick.

The Torqeedo propulsion package consists of a Cruise 10.0 outboard with two Power 48-5000 lithium-ion batteries weighing just 36 kg each. A cockpit control panel gives the operator a view of system status, including range at current speed. The system delivers six to eight hours of service between charges.

"The main advantage of working with Torqeedo is, as a builder and vessel designer, we benefit from the engineering and technological developments put into the products, their highly efficient performance and reliability, and most importantly a cost-effective option for electric drive," Caddick added. "And the support available for professional installers is very impressive."

Historic sailboat rentals go electric



"Our customers obviously approve, because our bookings are increasing and the boats with engines are the first to be booked. There is a waiting list for them too." *Phillip Bray, Hunter's Trust*

Hunter's Yard runs a rental fleet of traditional wooden sailboats on the Norfolk Broads in Eastern England with a loyal base of customers who share a mutual appreciation for the historic vessels and their way of life.

In recent years, Hunter's Yard began to see a falloff in business as older customers found the rigours of quanting to be increasingly difficult, and younger families with children wanted the convenience of motorised propulsion. It became clear that auxiliary motors would be needed, but it had to be done in a way that would not affect the boats' sailing characteristics or destroy their historical allure.

After a good deal of research, the Hunter's Yard management installed a Torqeedo electric propulsion system on a trial boat.

The package consists of a Torqeedo Cruise 2.0 electric pod motor with a folding propeller, two Power 24-3500 batteries, fast charger, shore power box and control/display unit. "We refer to it as an 'electric quant,'" said Philip Bray, secretary of the Hunter's Trust, which owns and operates the sailboat fleet. The first electrified boat was an instant hit amongst renters, and additional boats were fitted with the same package the following year. Now the number is up to five, with more in the queue.



1 x Cruise 2.0 FP



2 x Power 24-3500

Main advantages



Kenya eco-fishing



"I hope that in a few years our business model will not just be working on Lake Victoria but in emerging markets all over the world."

Laurens Friso, ASOBO



1 x Cruise 4.0 R



2 x Power 24-3500



Solar

Main advantages



ASOBO is testing a unique business model in Mbita, a small fishing town in Kenya. Torqeedo electric motors are rented out to the local fishermen for a monthly fee that includes financing, training, maintenance, and a solar-powered battery-charging service.

The goal is to massively reduce the negative effects of petrol engines on the world's second-largest freshwater lake. The livelihoods of 30-50 million people who, directly or indirectly, are dependent on the lake are also acutely threatened.

ASOBO developed an innovative leasing model in which the company purchases Cruise 4.0 T motors and rents them out to the fishermen. ASOBO also charges the 3.5 kWh Torqeedo Power 24-3500 batteries and provides back-up service in case anything goes wrong. When the fishermen return, an ASOBO employee

picks up the batteries on his electric-powered workbike and takes them to a solar power station not far away. Before the boats set out again, the batteries are back on board.

The efficient, narrow hulls of the fishing boats glide over the water, 100% emission-free. The batteries supply plenty of power for the long trips to the fishing grounds, and the onboard computer with its integrated GPS range calculator tells the fishermen, second for second, exactly how much range they have left. What's more, the quiet electric motors make the actual job of fishing a more pleasant task, and the fishermen can also manoeuvre their boats much more precisely. Without the noisy petrol outboards, the fishermen can easily understand the commands they shout to each other and listen to the radio while waiting for their catch.

XOCEAN autonomous survey vessel



"Our USVs have a negligible carbon footprint, only producing about one-thousandth of the emissions of a conventional survey vessel." *James Ives, XOCEAN*



2 x Cruise 2.0 FP



Power 24-3500



Solar

Main advantages



XOCEAN is out to transform the way subsea data is collected.

The three-year-old company based in Ireland provides turnkey underwater data acquisition services with its growing fleet of innovative unmanned surface vessels (USVs) which deliver an unprecedented combination of safety, versatility, efficiency and productivity.

And thanks to Torqeedo's electric propulsion systems, they are also nearly 100% emission free.

XOCEAN's XO-450 USV is a custom-designed composite wave-piercing catamaran about the length of a typical automobile. The lightweight vessel is powered

by a pair of Torqeedo Cruise 2.0 electric pod drives, with a Power 24-3500 lithium ion battery and a lightweight micro generator. Solar panels on deck provide efficient recharging during daylight hours.

The two electric thrusters are controlled separately by the remote controller to adjust the speed on each side, steering the boat on the desired course. A pair of Torqeedo Ultralight outboards at the bows enhance the vessel's station keeping abilities when gathering data.

XOCEAN reports that the boat's operating range is 1,500 nautical miles, providing up to 18 days mission endurance operating 24/7.

Zero-emission commuter ferry in Thailand

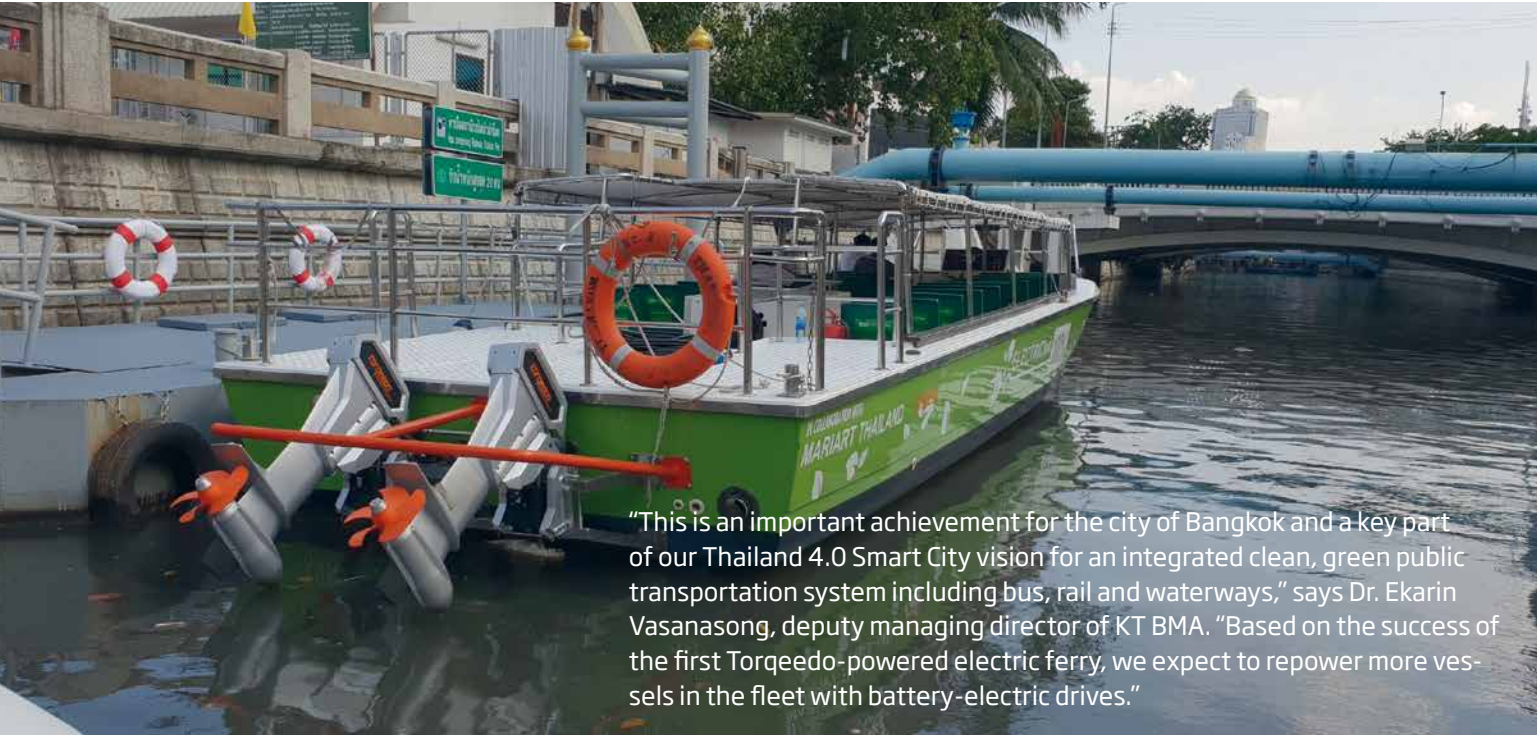

"This is an important achievement for the city of Bangkok and a key part of our Thailand 4.0 Smart City vision for an integrated clean, green public transportation system including bus, rail and waterways," says Dr. Ekarin Vasanasong, deputy managing director of KT BMA. "Based on the success of the first Torqeedo-powered electric ferry, we expect to repower more vessels in the fleet with battery-electric drives."



2 x Cruise 10.0 R



12 x lithium battery banks

Main advantages



Thailand's first all-electric commuter ferry was placed into service in 2018 by the Bangkok Metropolitan Authority (BMA), powered by twin Cruise 10.0 electric outboards.

Prime Minister Prayut Chan-o-cha celebrated the launch, giving his symbolic approval to the city's efforts to ease congestion and improve air quality through investments in green transportation. The Prime Minister commuted by skytrain, subway and foot through Bangkok's crowded streets, before ending his mixed-mode commute with a trip aboard the emission-free passenger ferry. Switching from diesel to electric power eliminates fuel costs, reduces air and water pollution and creates greater passenger satisfaction with a smooth quiet

ride and no diesel fumes on deck.

The 47.5-ft fibre-glass vessel was repowered by MariArt Shipyard, replacing the existing 205 hp diesel engine with twin Torqeedo Cruise 10 kW electric outboards. Each motor is powered by a 48 V bank of six 24 V Power batteries and two fast chargers.

The 40-passenger vessel is part of a fleet of ferries operated by BMA's Enterprise Krungthep Thanakom Company (KT BMA) and operates on a 5 km route daily between Hua Lampjong and Thewes Pier. 12 more ferries will be launched in the first quarter of 2021.

Safer ports with new hydrography boat



Cassiopée collects data used to map the underwater landscape, ensuring safe navigation in and around the port.



2 x Cruise 10.0 R



8 x Power 48-5000

Main advantages



Alumarine Shipyard has delivered a new hydrographic survey boat that is powered by an innovative dual electric/diesel propulsion system to the Port of La Rochelle.

Torqueedo worked closely with the naval architect and shipyard to specify, install and integrate an electric propulsion package consisting of two Cruise 10.0 R electric outboards, each powered by four Power 48-5000 lithium batteries. It also includes an intelligent Battery Management System that automatically monitors all components and communicates with the onboard computer.

The eight-metre aluminium vessel dubbed Cassiopée is designed to transit at 20-25 knots under diesel power between the home port and the acquisition

area, then shift to the electric outboards while performing scans of the sea-floor.

“The dual-mode propulsion system gives the best of both worlds - high-speed transits to maximize uptime on station and efficient, emission-free slow-speed operation for long periods when conducting an underwater survey,” said Franck Souchay, captain of Cassiopée. “The boat operates on electric power at a speed of 5 knots for 6 hours, which perfectly covers our needs in electric mode on a working day. Then the batteries are recharged at the pier during the night.”

China takes on plastic pollution



The Suzhou River Management Administration commissioned the construction of 177 Torqeedo-powered vessels designed specifically to remove plastic and floating debris from the water.



2 x Cruise 4.0 R



2 x 48 V banks of 8 x 12 V lithium batteries

Main advantages



The City of Suzhou in eastern China uses a fleet of 177 electric workboats powered by Torqeedo motors as part of a program to clean up its canals and waterways.

The ancient city, located in Jiangsu Province near Shanghai, is home to more than 10 million people. Often called the “Venice of the East” the 2,500-year-old city is noted for its many canals, rivers, lakes, ancient stone bridges, pagodas and gardens. Suzhou Creek, which flows through the city and then through the center of Shanghai, was once said to be the most contaminated waterway in the country.

China is committed to cleaning up this tributary of the Yangtze River, an effort with global implications. In combination with its own waste, China also took

much of the world’s unwanted plastic until recently. 7.3 million tonnes of trash was imported in 2016 and 55% of all plastic waste deposited into the ocean by rivers flows out of the Yangtze.

As part of the clean-up program, the Suzhou River Management Administration commissioned the construction of electric-powered vessels designed specifically to remove plastic and floating debris from the water.

Torqeedo motors now power the entire fleet, which includes 18 nine-metre steel catamarans with twin Cruise 4.0 outboards, 22 seven-metre steel catamarans with twin Cruise 2.0 outboards and 137 five/six-metre wooden boats with Cruise 2.0 outboards.

US solar-powered boat protects human health

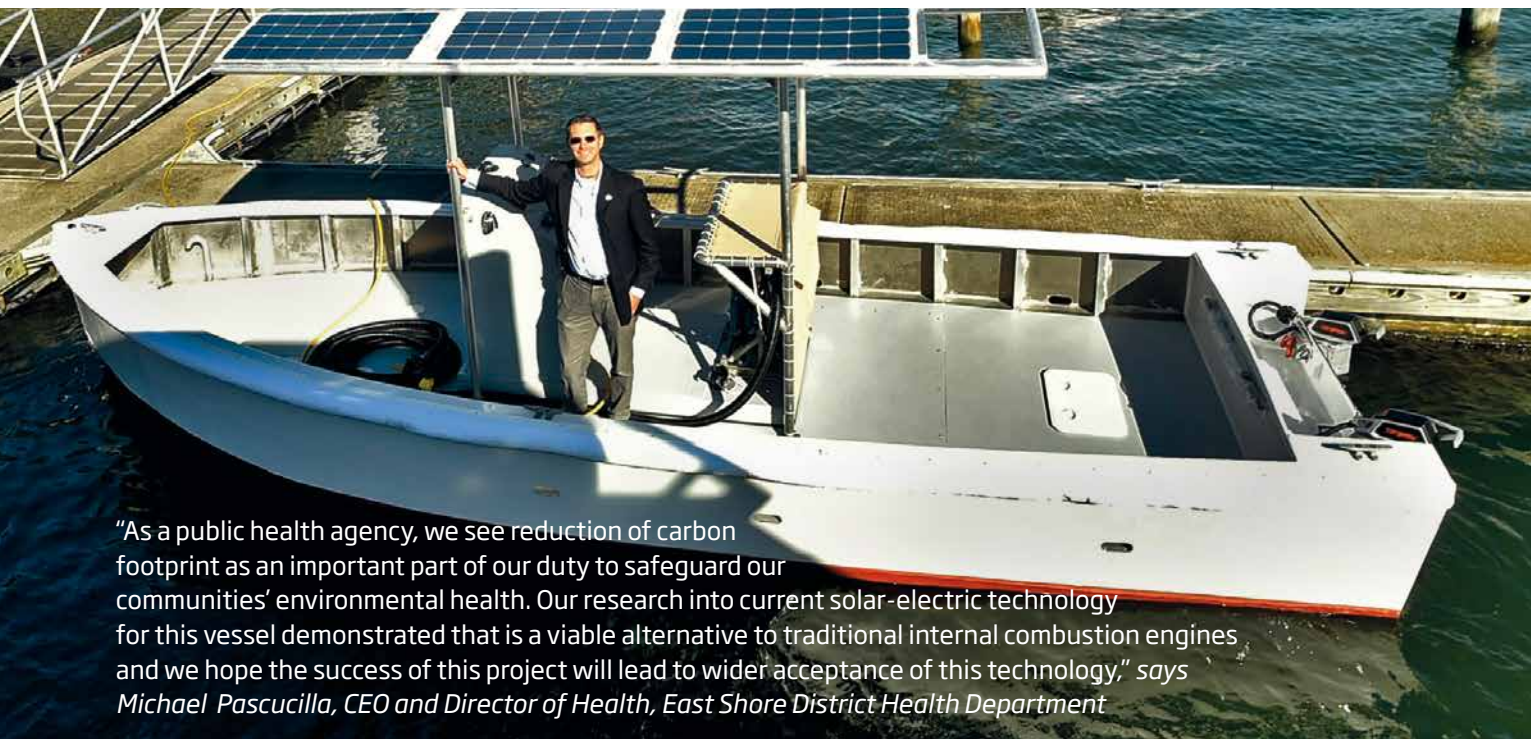

"As a public health agency, we see reduction of carbon footprint as an important part of our duty to safeguard our communities' environmental health. Our research into current solar-electric technology for this vessel demonstrated that is a viable alternative to traditional internal combustion engines and we hope the success of this project will lead to wider acceptance of this technology," says Michael Pascucilla, CEO and Director of Health, East Shore District Health Department



2 x Cruise 4.0 R



2 bank of 2 x 48 V
Power batteries



Solar

Main advantages



Torqeedo supplied the integrated electric propulsion system for the world's first full-size solar-electric sewage pump-out boat. The solar-electric vessel offers a clean, green, zero-fuel, zero-emission solution with long life, low maintenance and minimal operating costs.

The 25-ft. aluminium boat was built for the East Shore District Health Department in the USA to provide free sewage pump-out service for boats, preventing the discharge of untreated human waste into waterways.

The boat is propelled by twin Cruise 4.0 outboard motors, four Power 48-5000 lithium-ion batteries and four chargers, and also has a cockpit control panel that gives the operator an at-a-glance view of system status.

The batteries are recharged by eight 100 W solar panels, providing 400 W to each battery bank. The batteries also drive the boat's pump and provide enough reserve capacity for a full day's work.

The East Shore District Health Department collaborated with Yale University's School of Public Health on research and funding was provided by a grant under the Federal Clean Vessel Act as well as local fundraising efforts. The Clean Vessel Act provides assistance to build and maintain pump-out stations, pump-out boats and dumping stations that enable recreational boaters to dispose of sewage in a safe and responsible fashion, keeping it out of waterways.

Google maps rising sea levels

“A lot of people know about sea level rise,” says Sejal Choksi, an environmental lawyer and Baykeeper’s interim director. “We are hoping these images will really bring the reality home to the public, that they will look at pictures of places they know and say, ‘Oh my gosh, this is going to be underwater.’”

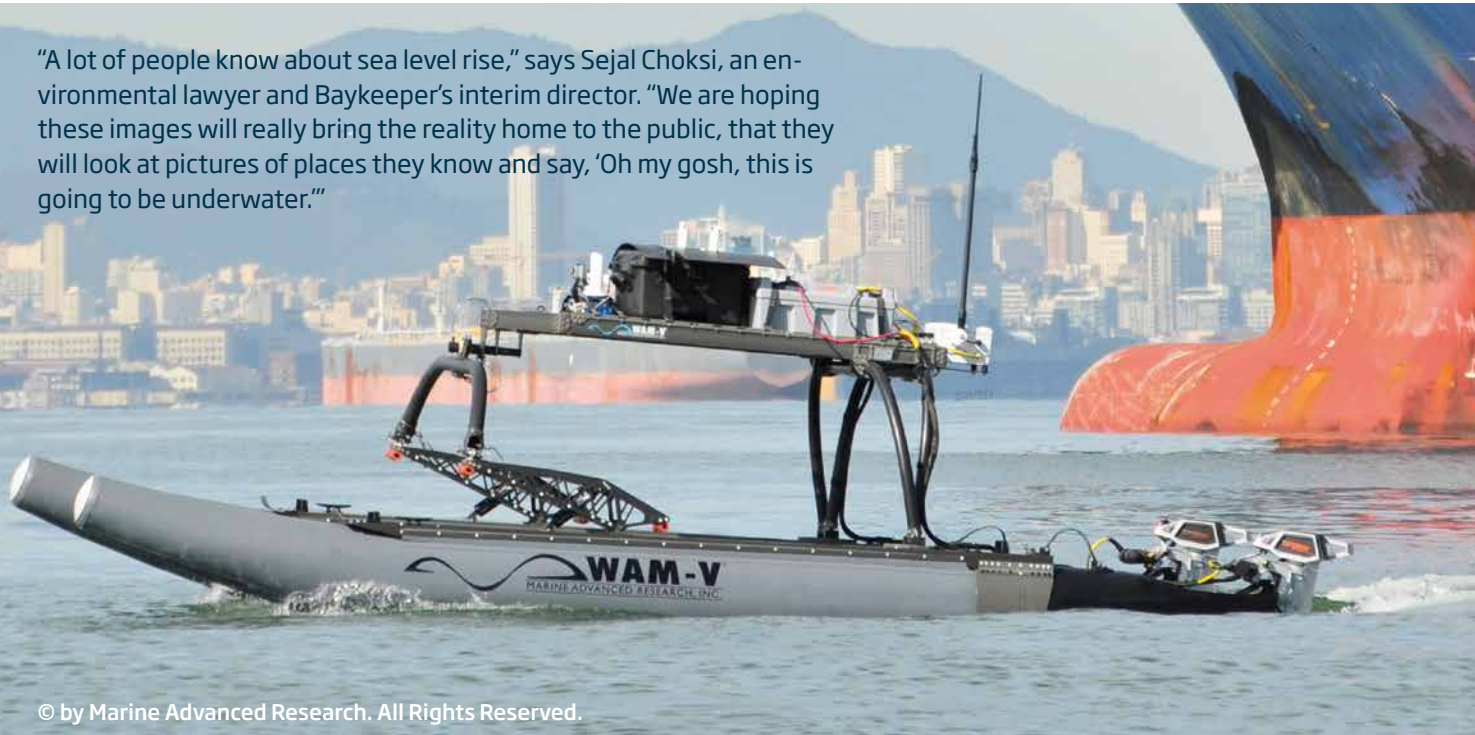

© by Marine Advanced Research. All Rights Reserved.



2x Cruise 4.0 R



2 48 V banks of 2 x 24 V
Power batteries



Solar

Main advantages



An unmanned Google boat is mapping shorelines to raise awareness of the impacts of sea level rise. The ShoreView project was developed by San Francisco Baykeeper, with support from Google.

Originally designed to be worn by backpackers, Google’s proprietary Street View Trekker camera system was provided on loan to the Baykeeper organization. It was mounted on a small, remote-controlled catamaran, the Wave Adapted Modular Vehicle (WAM-V) designed by Marine Advanced Robotics.

The WAM-V features an adaptive hull design that flexes to adapt to the water’s surface for ultimate stability and is powered by twin Cruise 4.0 R outboard

motors and two 48 V banks of 24 V Power batteries. The WAM-V is able to run for hours with nearly zero environmental footprint thanks to its solar charging capabilities with plug-in charging backup.

The Baykeeper organization is using the imagery collected – nearly 500 miles of coastline ranging from San Jose to Antioch, California – on its website and for educational purposes, helping to illustrate the threats posed by global sea level rise to California’s economy and the health of its waters and residents. The organization estimates that San Francisco Bay could rise 1 metre by the end of this century, which could result in the flooding of 42,000 homes and businesses and a US\$70 million economic loss.

Eco Dive boats in Raja Ampat, Indonesia

“Our partnership with Torqeedo was key for our success. Torqeedo provided us with the right support to implement and test the electric motor and battery systems. The next step is to share the electric motors with the local Papuan villages to allow them to travel in a way that’s healthier for them and for the environment,” says Mahasti Motazed, founder of MahaRaja Eco Dive Lodge



1x Cruise 4.0 T



2 x Power 24-3500

Main advantages



The MahaRaja Eco Dive Lodge offers a sustainable and climate-friendly diving experience after switching to emission-free dive boats powered by Torqeedo electric outboards. Raja Ampat is a dream destination for scuba divers and snorkelers thanks to its rich marine life, which includes more than 1,300 species of fish and 75% of all the hard-coral species on the planet. Protecting the coral reefs from the ravages of climate change and pollution while maintaining public access is a high priority, so MahaRaja has transformed two traditional Papuan long boats into electric dive boats. The first boat is a 22-metre long boat equipped with a Torqeedo Cruise 4.0 motor and lithium-ion batteries. The boat has a range of up to 20 km with one charge, which is more than enough to transport 12 divers to and from the dive sites. The second boat is an 8-metre long boat equipped with a Torqeedo Travel 1003 and is used for up to six passengers on trips of 10 km or less.



TORQEEDO

Torqueedo North America

T +1-815 - 444 - 8806
usa@torqeedo.com

Torqueedo Germany, Austria, Switzerland

T +49 (0) 8153 - 92 15 - 100
info@torqeedo.com

Torqueedo Italy

T +39 345 833 27 66
italy@torqeedo.com

Torqueedo United Kingdom/Ireland

T +44 (0) 1502 - 516 224
uk@torqeedo.com

Torqueedo Asia-Pacific

T +66 212 680 15
apac@torqeedo.com

Torqueedo France

T +33 (0) 240 - 010 604
france@torqeedo.com

All other countries

Torqueedo GmbH
Friedrichshafener Str. 4a
82205 Gilching
Germany
T +49 (0) 8153 - 92 15 - 100
F +49 (0) 8153 - 92 15 - 319
info@torqeedo.com

Torqueedo Spain/Portugal

T +34 609 38 50 44
iberia@torqeedo.com



This catalogue is printed on chlorine-free paper sourced from exemplary forestry.

Goods are delivered exclusively according to our Terms of Sale and Delivery and according to Torqeedo's current Terms and Conditions of Business.

We reserve the right to make any changes, including pricing, at any time.

www.torqeedo.com